

ORGATEC
OCTOBER 27-31, 2020 HALL 10.1 F-070

2 0 2 0

Available on
pcon
PLANNER

CATALOGUE

CATALOGUE

KATALOG



Reyem
since 1984



CLOISONNETTES +
SOLUTIONS ACOUSTIQUES

ABSICES
Créateur et agenceur
d'espace
Avenue de L'Auvitrie 19500 Meyssac
Tél : 05 87 49 40 13
www.absices.com





NEW

PAGE 41

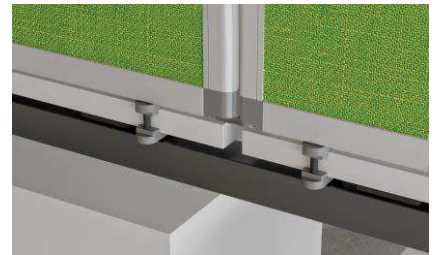



- CLOISONS MOBILES A ANGLE DROIT SUR ROULETTES (PAGE 30)



- FREESTANDING ANGLE PARTITIONS ON CASTORS (PAGE 30)



- BEWEGLICHE ECKTRENNWÄNDE AUF ROLLEN (SEITE 30)





- CLOISONS BASSES
- SEPARATIONS D'AMBIANCE
- PANNEAUX ACOUSTIQUES



- OFFICE SCREENS
- PARTITION SYSTEM
- ACOUSTIC PANELS



- STELLWÄNDE
- TRENNWAND-SYSTEM
- AKUSTIK-WÄNDE



PAGE 23



- ECRANS DE BUREAU
- BANQUES D'ACCUEIL
- PANNEAUX SUSPENDUS



- DESK SCREENS
- RECEPTION DESKS
- HANGING PANELS



- TISCH-TRENNWÄNDE
- EMPFANGSTHEKE
- AKUSTIK-HÄNGEPANEELE





- POSTES DE TRAVAIL
- CALL CENTER



- WORKSTATIONS
- CALL CENTER



- ARBEITSPLÄTZE
- CALL CENTER

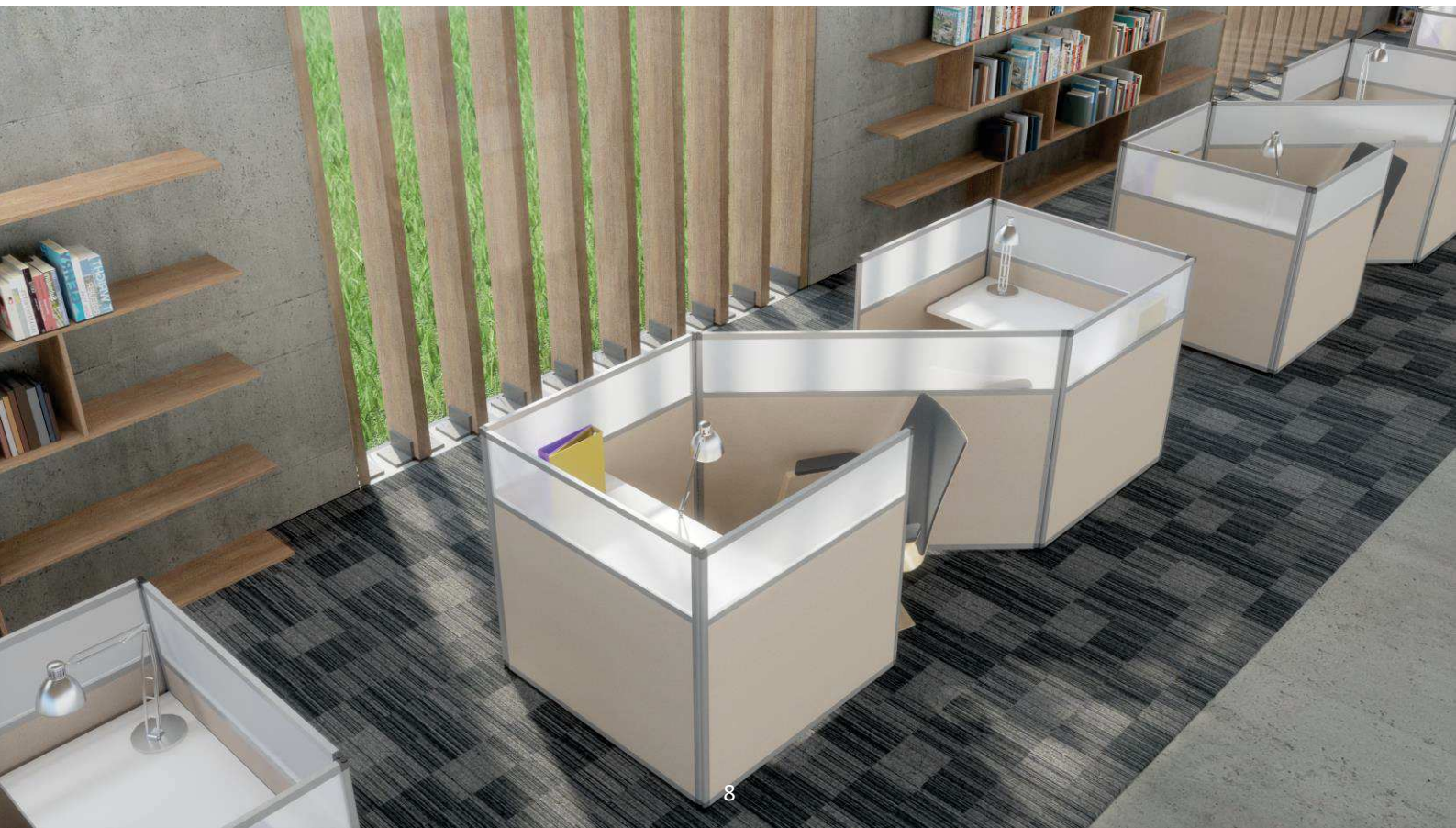



- BANQUES D'ACCUEIL
- SOLUTIONS ACOUSTIQUES



- RECEPTION DESKS
- ACOUSTIC SOLUTIONS



- EMPFANGSTHEKE
- AKUSTISCHE LÖSUNGEN





FICHE TECHNIQUE

Ossature

Toutes les cloisons Reyem sont fabriquées avec une ossature en aluminium anodisé nature de 30mm, d'épaisseur 22mm et assemblées avec des pièces d'angle en alliage de zinc, peinture liquide RAL 9006.

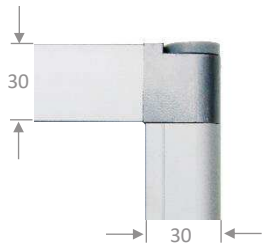

TECHNICAL DATA

Frame

Each Reyem screen is made using a colourless, anodised aluminium frame of 30mm and 22mm thick. The frame is assembled with corner pieces made of a zinc alloy, liquid paint RAL 9006.



TECHNISCHEN DATEN

Rahmen

Jede Reyem-Wand wird mit einem 30mm und 22mm dicken Rahmen aus farblosem, eloxiertem Aluminium gefertigt. Der Rahmen wird mit zinklegierungen Eckstücken, flüssige Farbe RAL 9006 zusammengesetzt.

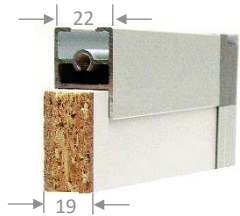

Mélangé (page 14)

Finition mélaminé d'épaisseur 19mm de la gamme Kronoswiss 100% PEFC et FSC, classement au feu M3 / D, s2, d0.

(www.swisskrono.ch)

Classement au feu M1 / B, s2, d0 possible, veuillez nous consulter pour prix et délais. Coloris page 44

Melamine (page 14)

19mm thick melamine from Kronoswiss 100% PEFC and FSC, fire safety classification: D, s2, d0.

(www.swisskrono.ch)

Fire safety classification B, s2, d0 possible, please contact us for price and delivery time.

Colours page 44

Melamin (Seite 14)

19mm Melamin von Kronoswiss 100% PEFC- und FSC-zertifiziert, Feuersicherung: D, s2, d0.

(www.swisskrono.ch)

Feuersicherung B, s2, d0 möglich, bitte kontaktieren Sie uns für Preis und Lieferzeit.

Melaminfarben Seite 44

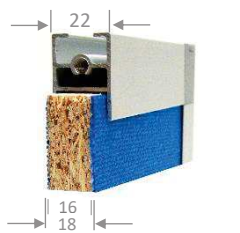

Tissu (page 16)

Aggloméré de 16mm 100% PEFC et FSC + Colle à l'eau

+ Tissu CARA ou LUCIA (voir page 45)

Tests acoustiques page 46

Fabric (page 16)

16mm thick chipboard 100% PEFC et FSC + Water glue

+ CARA or LUCIA fabric (see page 45)

Acoustic tests page 46

Stoff (Seite 16)

16mm Spanplatten 100% PEFC- und FSC-zertifiziert

+ Wasser-Leim

+ CARA oder LUCIA Stoff (siehe Seite 45)

Akustikteste Seite 46

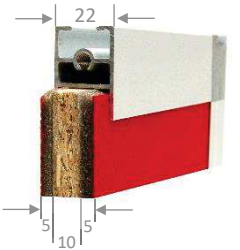

Acoustique (page 18)

Aggloméré de 10mm 100% PEFC et FSC + 2 x 5mm de mousse 100% polyuréthane, densité 23 kg/m³

+ Colle à l'eau

+ Tissu CARA ou LUCIA (voir page 45)

Tests acoustiques page 46

Acoustic (page 18)

10mm thick chipboard 100% PEFC et FSC + 2 x 5mm foam 100% polyurethane, density 23 kg/m³

+ Water glue

+ CARA or LUCIA fabric (see page 45)

Acoustic tests page 46

Akustik (Seite 18)

10mm Spanplatten 100% PEFC- und FSC-zertifiziert

+ 2 x 5mm Schaum 100% Polyurethan, Dichte 23 kg/m³

+ Wasser-Leim

+ CARA oder LUCIA Stoff (siehe Seite 45)

Akustikteste Seite 46

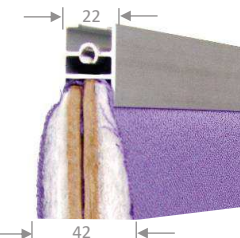

Super-Acoustique (page 20)

2 x 5mm de Medium Density Fibreboard (MDF)

+ 2 x 15mm de fibre 100% polyester, densité 30 kg/m³

+ Tissu CARA ou LUCIA (voir page 45)

Tests acoustiques page 46

Super-Acoustic (page 20)

2 x 5mm thick Medium Density Fibreboard (MDF)

+ 2 x 15mm 100% polyester fibre, density 30 kg/m³

+ CARA or LUCIA fabric (see page 45)

Acoustic tests page 46

Super-Akustik (Seite 20)

2 x 5mm Medium Density Fibreboard (MDF)

+ 2 x 15mm 100% Polyesterfaser, Dichte 30 kg/m³

+ CARA oder LUCIA Stoff (siehe Seite 45)

Akustikteste Seite 46

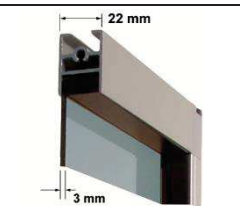

Verre acrylique (page 24)

Finition verre acrylique 3mm. Transparent gris, incolore ou opale, résistance durable aux UV, classement feu M4 / E.

+ Profilé de compensation en PVC noir

Acryl glass (page 24)

3mm thick acryl glass. Gray transparent, colourless or opal, long-lasting UV resistance, fire safety classification: E.

+ compensator profile made of black PVC

Acrylglas (Seite 24)

3mm Acrylglas, grau transparent, Klar oder Opal. Langlebig UV-beständig, Feuersicherung: E.

+ Kompensator Profil schwarz PVC



Polycarbonate alvéolaire (page 24)

Finition polycarbonate alvéolaire incolore 6mm. Protection UV par coextrusion, classement au feu M1 / B, s1, d0

+ Profilé de compensation en PVC noir

Alveolar Polycarbonate (page 24)

6mm thick colourless alveolar polycarbonate. UV protection by coextrusion, fire classification: B, s1, d0 + compensator profile made of black PVC

Polycarbonat (Seite 24)

6mm Klarpolycarbonat, UV-beständigkeit (Coextrusion), Feuersicherung Class B, s1, d0.

+ Kompensator Profil schwarz PVC

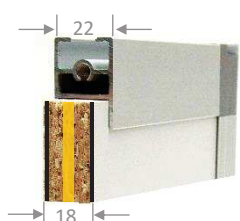

Affichage magnétique (page 26)

Face magnétique émaillée writable & effaçable blanche (disponible en 1 ou 2 faces)

Magnetic notice boards (page 26)

Enamelled white magnetic writable side (available on 1 or 2 sides)

Magnetische Anschlagtafeln (Seite 26)

Emailiert weiß magnetisch und beschreibbar Seite (Verfügbar auf 1 oder 2 Seiten)



SOMMAIRE

6 raisons de choisir Reyem

Cloisonnettes mélaminé

Cloisonnettes tissu

Cloisonnettes acoustiques
mousse + tissu

Cloisonnettes Super-Acoustique

Cloisonnettes verre acrylique &
polycarbonate

Panneaux d'affichage
magnétiques

Accessoires cloisonnettes,
piétement & roulettes

Cloisons d'angle mobiles sur
roulettes

Panneaux pour banque d'accueil

Postes de travail & Call Center

Ecrans de bureau, fixations &
accessoires

NOUVEAU Fixation pour bureaux
Bench

Coloris

Tests acoustiques

Conditions de transport



TABLE OF CONTENTS

6 reasons to choose Reyem

Melamine screens

Fabric screens

Acoustic screens
foam + fabric

Super-Acoustic screens

Acryl glass & Polycarbonate
screens

Magnetic notice boards

Accessories for screens, feet &
castors

Freestanding angle screens on
castors

Panels for reception desk

Workstations & Call center

Desk screens, fixing & accessories

NEW Fixing for Bench desks

Colours

Acoustic tests

Conditions of transport



INHALTSVERZEICHNIS

6 Gründe, sich für Reyem zu
entscheiden

Melamin-Stellwände

Stoff-Stellwände

Akustik-Stellwände
Schaum + Stoff

Super Akustik-Stellwände

Acrylglas- & Polycarbonat-
Stellwände

Magnetische Anschlagtafeln

Zubehör für Stellwände,
Fuß & Rollen

Bewegliche Ecktrennwände auf
Rollen

Wände für Empfangstheke

Arbeitsplätze & Call Center

Tisch-Trennwände,
Befestigungen & Zubehör

NEU Befestigung für Bench
Schreibtische

Farben

Akustikteste

Beförderungsbedingungen

12

14

16

18

20

24

26

28

30

33

34

38

41

44

46

47



6 RAISONS DE CHOISIR REYEM

✓ SYSTEME D'ASSEMBLAGE UNIQUE ET BREVETE

Chaque panneau Reyem est fabriqué avec un cadre en aluminium anodisé nature et est livré avec un kit de rondelles multidirectionnelles permettant de relier les panneaux entre eux.

✓ FONCTIONNEL & MODULABLE

Le système Reyem permet une multitude d'implantations pouvant s'adapter sur mesure à vos bureaux et ambiances.

✓ DESIGN MODERNE ET AFFINE

Nos matériaux de finition offrent des déclinaisons variées pour une créativité sans limite.

✓ MONTAGE FACILE ET RAPIDE

✓ GARANTIE 3 ANS

Notre savoir-faire acquis au cours de nos 36 ans d'expérience assure la qualité, la solidité et la durabilité de nos produits.

✓ UNE DEMARCHE ENVIRONNEMENTALE DURABLE

98% des cloisons Reyem sont recyclables. Nos panneaux sont issus d'exploitations forestières durables (100% PEFC et FSC).



6 REASONS TO CHOOSE REYEM

✓ UNIQUE, PATENTED ASSEMBLY SYSTEM

Each Reyem panel is made using a colourless, anodised aluminium frame and comes with a multi-directional washer kit to connect different panels together.

✓ FUNCTIONAL & MODULAR

The Reyem system is perfect for a wide range of applications. It can adapt as needed to suit your offices and your interiors.

✓ MODERN, REFINED DESIGN

Our materials offer a variety of finishes, allowing you to express your creativity as you desire.

✓ QUICK AND EASY TO INSTALL

✓ 3 YEAR GUARANTEE

With 36 years in the industry, we've got the skill and expertise to ensure the highest quality, robustness and durability for our products.

✓ WORKING TOWARDS SUSTAINABLE DEVELOPMENT

98% of all Reyem screens are recyclable. The wood for our panels is sourced from sustainable managed forests (100% PEFC and FSC).



6 GRÜNDE, SICH FÜR REYEM ZU ENTSCHEIDEN

✓ EINZIGARTIGES UND PATENTIERTES MONTAGESYSTEM

Jede Reyem-Wand wird mit einem Rahmen aus farblosem, eloxiertem Aluminium gefertigt und mit einem Satz multidirektionaler Scheiben geliefert, mittels derer sich die Wände miteinander verbinden lassen.

✓ FUNKTIONAL & MODULIERBAR

Das Reyem-System ermöglicht eine Vielzahl von Anordnungsszenarien, die sich individuell an Ihre Büros und Raumgestaltungen anpassen lassen.

✓ MODERNES UND EDLES DESIGN

Unsere Oberflächenmaterialien bieten vielfältige Varianten für grenzenlose Kreativität.

✓ EINFACHE UND SCHNELLE MONTAGE

✓ 3 JAHRE GARANTIE

Dank unseres im Laufe unserer 36-jährigen Erfahrung erworbenen Know-how ist die Qualität, Haltbarkeit und Langlebigkeit unserer Produkte sichergestellt.

✓ NACHHALTIGER UMWELTANSATZ

98% der Reyem Stellwände sind recycelbar. Unsere Wände stammen aus nachhaltiger Waldbewirtschaftung (100% PEFC- und FSC-zertifiziert).





SYSTEME D'ASSEMBLAGE



ASSEMBLY SYSTEM



MONTAGESYSTEM



Metal

Plastic

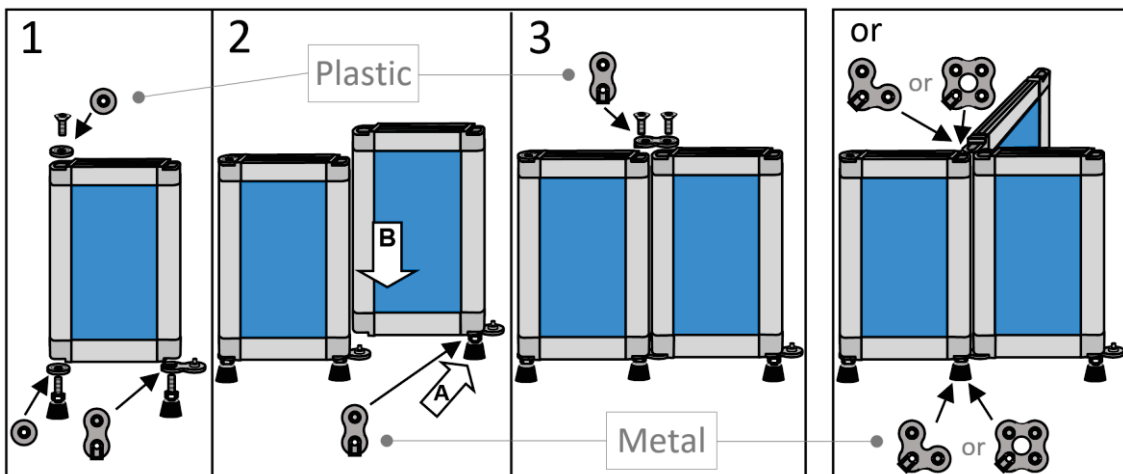
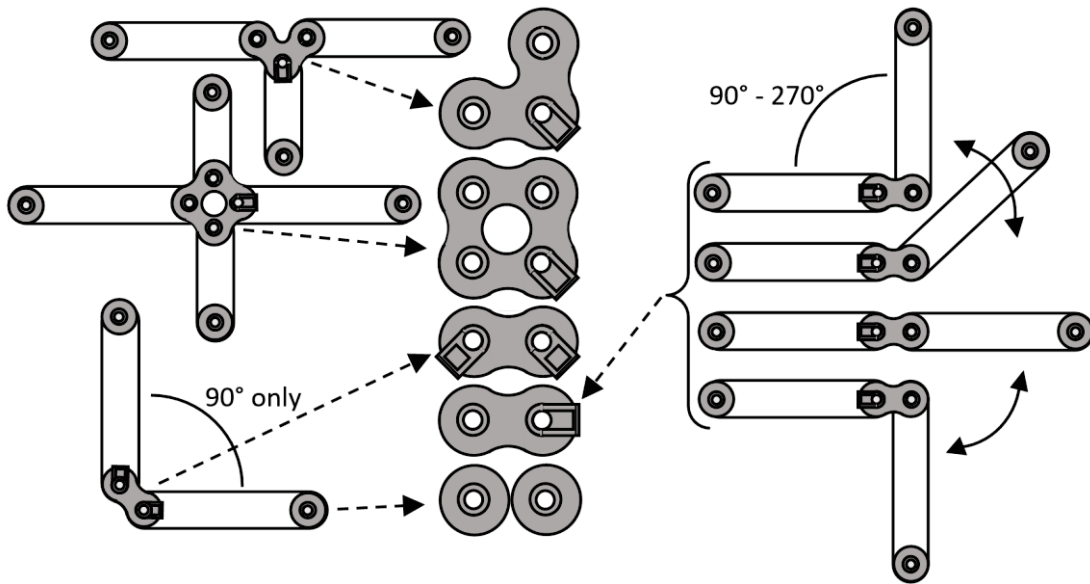

 **Hauteur**
 **Height**
 **Höhe**

1200 mm

1400 mm

1600 mm

1800 mm

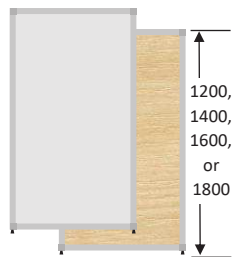



Ref. MMM 1200 x 610
Ref. MMM 1200 x 810
Ref. MMM 1200 x 1010
Ref. MMM 1200 x 1210
Ref. MMM 1200 x 1410
Ref. MMM 1200 x 1610

Ref. MMM 1400 x 610
Ref. MMM 1400 x 810
Ref. MMM 1400 x 1010
Ref. MMM 1400 x 1210
Ref. MMM 1400 x 1410
Ref. MMM 1400 x 1610

Ref. MMM 1600 x 610
Ref. MMM 1600 x 810
Ref. MMM 1600 x 1010
Ref. MMM 1600 x 1210
Ref. MMM 1600 x 1410
Ref. MMM 1600 x 1610

Ref. MMM 1800 x 610
Ref. MMM 1800 x 810
Ref. MMM 1800 x 1010
Ref. MMM 1800 x 1210
Ref. MMM 1800 x 1410
Ref. MMM 1800 x 1610

 Avec verre acrylique transparent gris 3mm

 With 3mm gray transparent acryl glass

 Mit 3mm grau transparent Acrylglas

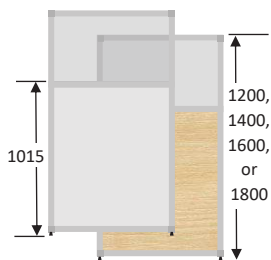

Ref. MMG 1200 x 610
Ref. MMG 1200 x 810
Ref. MMG 1200 x 1010
Ref. MMG 1200 x 1210
Ref. MMG 1200 x 1410
Ref. MMG 1200 x 1610

Ref. MMG 1400 x 610
Ref. MMG 1400 x 810
Ref. MMG 1400 x 1010
Ref. MMG 1400 x 1210
Ref. MMG 1400 x 1410
Ref. MMG 1400 x 1610

Ref. MMG 1600 x 610
Ref. MMG 1600 x 810
Ref. MMG 1600 x 1010
Ref. MMG 1600 x 1210
Ref. MMG 1600 x 1410
Ref. MMG 1600 x 1610

Ref. MMG 1800 x 610
Ref. MMG 1800 x 810
Ref. MMG 1800 x 1010
Ref. MMG 1800 x 1210
Ref. MMG 1800 x 1410
Ref. MMG 1800 x 1610

 Avec verre acrylique incolore 3mm

 With 3mm colourless acryl glass

 Mit 3mm Klaracrylglas

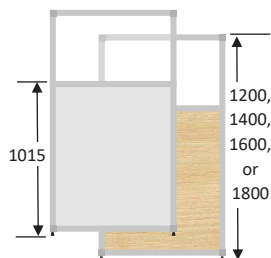

Ref. MMJ 1200 x 610
Ref. MMJ 1200 x 810
Ref. MMJ 1200 x 1010
Ref. MMJ 1200 x 1210
Ref. MMJ 1200 x 1410
Ref. MMJ 1200 x 1610

Ref. MMJ 1400 x 610
Ref. MMJ 1400 x 810
Ref. MMJ 1400 x 1010
Ref. MMJ 1400 x 1210
Ref. MMJ 1400 x 1410
Ref. MMJ 1400 x 1610

Ref. MMJ 1600 x 610
Ref. MMJ 1600 x 810
Ref. MMJ 1600 x 1010
Ref. MMJ 1600 x 1210
Ref. MMJ 1600 x 1410
Ref. MMJ 1600 x 1610

Ref. MMJ 1800 x 610
Ref. MMJ 1800 x 810
Ref. MMJ 1800 x 1010
Ref. MMJ 1800 x 1210
Ref. MMJ 1800 x 1410
Ref. MMJ 1800 x 1610

 Avec verre acrylique opale 3mm

 With 3mm opal acryl glass

 Mit 3mm Opalacrylglas

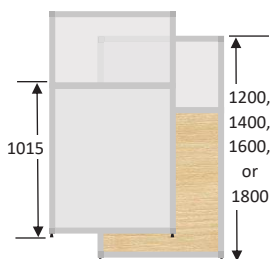

Ref. MML 1200 x 610
Ref. MML 1200 x 810
Ref. MML 1200 x 1010
Ref. MML 1200 x 1210
Ref. MML 1200 x 1410
Ref. MML 1200 x 1610

Ref. MML 1400 x 610
Ref. MML 1400 x 810
Ref. MML 1400 x 1010
Ref. MML 1400 x 1210
Ref. MML 1400 x 1410
Ref. MML 1400 x 1610

Ref. MML 1600 x 610
Ref. MML 1600 x 810
Ref. MML 1600 x 1010
Ref. MML 1600 x 1210
Ref. MML 1600 x 1410
Ref. MML 1600 x 1610

Ref. MML 1800 x 610
Ref. MML 1800 x 810
Ref. MML 1800 x 1010
Ref. MML 1800 x 1210
Ref. MML 1800 x 1410
Ref. MML 1800 x 1610

 Avec polycarbonate alvéolaire incolore 6mm

 With 6mm clear alveolar polycarbonate

 Mit 6mm Klarpolycarbonat

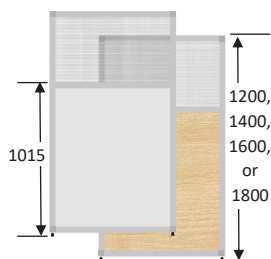

Ref. MMP 1200 x 610
Ref. MMP 1200 x 810
Ref. MMP 1200 x 1010
Ref. MMP 1200 x 1210
Ref. MMP 1200 x 1410
Ref. MMP 1200 x 1610

Ref. MMP 1400 x 610
Ref. MMP 1400 x 810
Ref. MMP 1400 x 1010
Ref. MMP 1400 x 1210
Ref. MMP 1400 x 1410
Ref. MMP 1400 x 1610

Ref. MMP 1600 x 610
Ref. MMP 1600 x 810
Ref. MMP 1600 x 1010
Ref. MMP 1600 x 1210
Ref. MMP 1600 x 1410
Ref. MMP 1600 x 1610

Ref. MMP 1800 x 610
Ref. MMP 1800 x 810
Ref. MMP 1800 x 1010
Ref. MMP 1800 x 1210
Ref. MMP 1800 x 1410
Ref. MMP 1800 x 1610

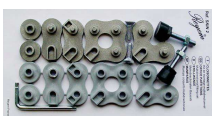

 Chaque cloisonnette est livrée avec un kit de montage (voir page 13)

 A fitting set is supplied with each partition (see page 13)

 Ein Bausatz versorgt mit jeder Stellwand (siehe Seite 13)

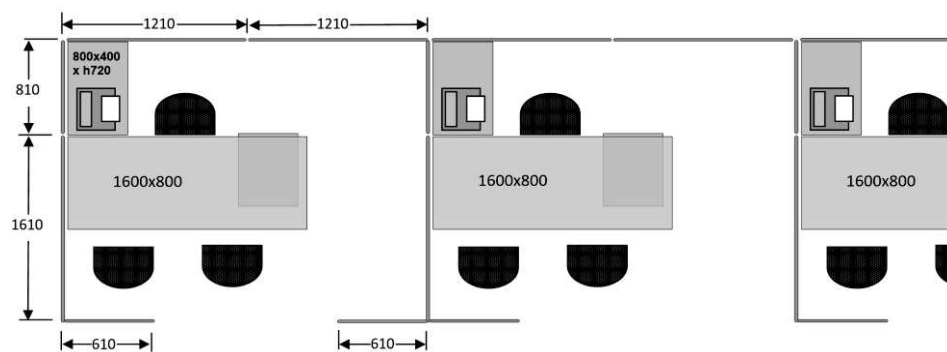

✓ **FABRICATION SUR
MESURE**

POSTES DE TRAVAIL

Cloisonnettes mélaminé
&
Verre acrylique (page 24)

Hauteur 1600mm



✓ **CUSTOM-MADE**

WORKSTATIONS

Melamine
&
Acryl glass screens (page 24)

1600mm High



✓ **HERSTELLUNG NACH MAß**

ARBEITSPLÄTZE

Melamin
&
Acrylglas Stellwände (Seite 24)

Höhe 1600mm

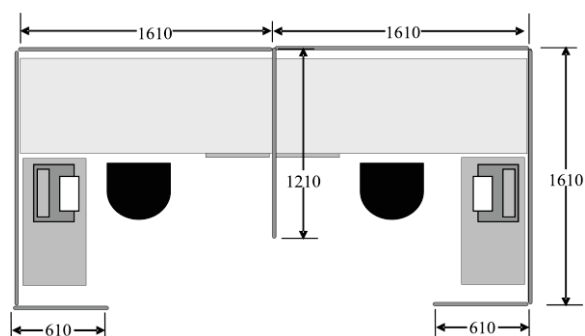



CLOISONNETTES TISSU

CARA ou LUCIA
Coloris page 45



FABRIC SCREENS

CARA or LUCIA
Colours page 45



STOFF STELLWÄNDE

CARA ODER LUCIA
Farben Seite 45

Hauteur
 Height
 Höhe

1200 mm

1400 mm

1600 mm

1800 mm

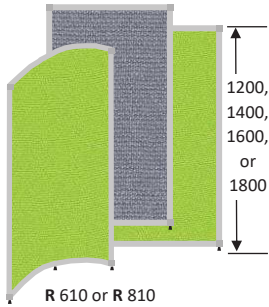

Ref. MTT 1200 x 610
Ref. MTT 1200 x 810
Ref. MTT 1200 x 1010
Ref. MTT 1200 x 1210
Ref. MTT 1200 x 1410
Ref. MTT 1200 x 1610

Ref. MTT 1200 x R 610
Ref. MTT 1200 x R 810

Ref. MTT 1400 x 610
Ref. MTT 1400 x 810
Ref. MTT 1400 x 1010
Ref. MTT 1400 x 1210
Ref. MTT 1400 x 1410
Ref. MTT 1400 x 1610

Ref. MTT 1400 x R 610
Ref. MTT 1400 x R 810

Ref. MTT 1600 x 610
Ref. MTT 1600 x 810
Ref. MTT 1600 x 1010
Ref. MTT 1600 x 1210
Ref. MTT 1600 x 1410
Ref. MTT 1600 x 1610

Ref. MTT 1600 x R 610
Ref. MTT 1600 x R 810

Ref. MTT 1800 x 610
Ref. MTT 1800 x 810
Ref. MTT 1800 x 1010
Ref. MTT 1800 x 1210
Ref. MTT 1800 x 1410
Ref. MTT 1800 x 1610

Ref. MTT 1800 x R 610
Ref. MTT 1800 x R 810

Avec verre acrylique transparent gris 3mm
 With 3mm gray transparent acryl glass
 Mit 3mm grau transparent Acrylglas

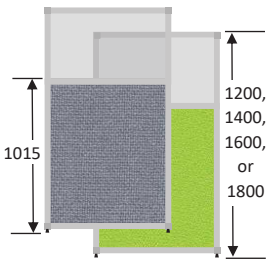

Ref. MTG 1200 x 610
Ref. MTG 1200 x 810
Ref. MTG 1200 x 1010
Ref. MTG 1200 x 1210
Ref. MTG 1200 x 1410
Ref. MTG 1200 x 1610

Ref. MTG 1400 x 610
Ref. MTG 1400 x 810
Ref. MTG 1400 x 1010
Ref. MTG 1400 x 1210
Ref. MTG 1400 x 1410
Ref. MTG 1400 x 1610

Ref. MTG 1600 x 610
Ref. MTG 1600 x 810
Ref. MTG 1600 x 1010
Ref. MTG 1600 x 1210
Ref. MTG 1600 x 1410
Ref. MTG 1600 x 1610

Ref. MTG 1800 x 610
Ref. MTG 1800 x 810
Ref. MTG 1800 x 1010
Ref. MTG 1800 x 1210
Ref. MTG 1800 x 1410
Ref. MTG 1800 x 1610

Avec verre acrylique incolore 3mm
 With 3mm colourless acryl glass
 Mit 3mm Klaracrylglas

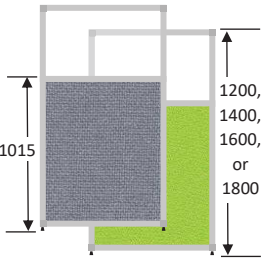

Ref. MTJ 1200 x 610
Ref. MTJ 1200 x 810
Ref. MTJ 1200 x 1010
Ref. MTJ 1200 x 1210
Ref. MTJ 1200 x 1410
Ref. MTJ 1200 x 1610

Ref. MTJ 1400 x 610
Ref. MTJ 1400 x 810
Ref. MTJ 1400 x 1010
Ref. MTJ 1400 x 1210
Ref. MTJ 1400 x 1410
Ref. MTJ 1400 x 1610

Ref. MTJ 1600 x 610
Ref. MTJ 1600 x 810
Ref. MTJ 1600 x 1010
Ref. MTJ 1600 x 1210
Ref. MTJ 1600 x 1410
Ref. MTJ 1600 x 1610

Ref. MTJ 1800 x 610
Ref. MTJ 1800 x 810
Ref. MTJ 1800 x 1010
Ref. MTJ 1800 x 1210
Ref. MTJ 1800 x 1410
Ref. MTJ 1800 x 1610

Avec verre acrylique opale 3mm
 With 3mm opal acryl glass
 Mit 3mm Opalacrylglas

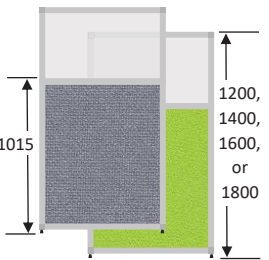

Ref. MTL 1200 x 610
Ref. MTL 1200 x 810
Ref. MTL 1200 x 1010
Ref. MTL 1200 x 1210
Ref. MTL 1200 x 1410
Ref. MTL 1200 x 1610

Ref. MTL 1400 x 610
Ref. MTL 1400 x 810
Ref. MTL 1400 x 1010
Ref. MTL 1400 x 1210
Ref. MTL 1400 x 1410
Ref. MTL 1400 x 1610

Ref. MTL 1600 x 610
Ref. MTL 1600 x 810
Ref. MTL 1600 x 1010
Ref. MTL 1600 x 1210
Ref. MTL 1600 x 1410
Ref. MTL 1600 x 1610

Ref. MTL 1800 x 610
Ref. MTL 1800 x 810
Ref. MTL 1800 x 1010
Ref. MTL 1800 x 1210
Ref. MTL 1800 x 1410
Ref. MTL 1800 x 1610

Avec polycarbonate alvéolaire incolore 6mm
 With 6mm clear alveolar polycarbonate
 Mit 6mm Klarpolycarbonat

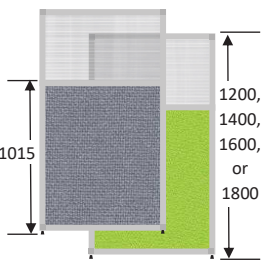

Ref. MTP 1200 x 610
Ref. MTP 1200 x 810
Ref. MTP 1200 x 1010
Ref. MTP 1200 x 1210
Ref. MTP 1200 x 1410
Ref. MTP 1200 x 1610

Ref. MTP 1400 x 610
Ref. MTP 1400 x 810
Ref. MTP 1400 x 1010
Ref. MTP 1400 x 1210
Ref. MTP 1400 x 1410
Ref. MTP 1400 x 1610

Ref. MTP 1600 x 610
Ref. MTP 1600 x 810
Ref. MTP 1600 x 1010
Ref. MTP 1600 x 1210
Ref. MTP 1600 x 1410
Ref. MTP 1600 x 1610

Ref. MTP 1800 x 610
Ref. MTP 1800 x 810
Ref. MTP 1800 x 1010
Ref. MTP 1800 x 1210
Ref. MTP 1800 x 1410
Ref. MTP 1800 x 1610



Chaque cloisonnette est livrée avec un kit de montage (voir page 13)

A fitting set is supplied with each partition (see page 13)

Ein Bausatz versorgt mit jeder Stellwand (siehe Seite 13)

Pour d'autres dimensions, consultez-nous
Coloris des tissus en page 45

For other dimensions, please contact us
For fabric colours, see page 45

Für andere Maße, kontaktieren Sie uns
Für Stofffarben, siehe Seite 45



✓ **BONNE STABILITE**



✓ **A STABLE SOLUTION**



✓ **GUTE STABILITÄT**





CLOISONNETTES ACOUSTIQUES

MOUSSE + TISSU CARA ou LUCIA

Coloris page 45



ACOUSTIC SCREENS

FOAM + CARA FABRIC or LUCIA

Colours page 45



AKUSTIK-STELLWÄNDE

SCHAUM + CARA STOFF oder LUCIA

Farben Seite 45

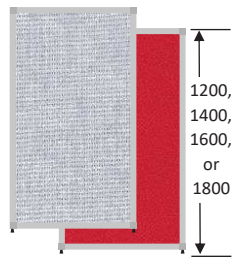

Hauteur
 Height
 Höhe

1200 mm

Ref. FTT 1200 x 610
Ref. FTT 1200 x 810
Ref. FTT 1200 x 1010
Ref. FTT 1200 x 1210
Ref. FTT 1200 x 1410
Ref. FTT 1200 x 1610

1400 mm

Ref. FTT 1400 x 610
Ref. FTT 1400 x 810
Ref. FTT 1400 x 1010
Ref. FTT 1400 x 1210
Ref. FTT 1400 x 1410
Ref. FTT 1400 x 1610

1600 mm

Ref. FTT 1600 x 610
Ref. FTT 1600 x 810
Ref. FTT 1600 x 1010
Ref. FTT 1600 x 1210
Ref. FTT 1600 x 1410
Ref. FTT 1600 x 1610

1800 mm

Ref. FTT 1800 x 610
Ref. FTT 1800 x 810
Ref. FTT 1800 x 1010
Ref. FTT 1800 x 1210
Ref. FTT 1800 x 1410
Ref. FTT 1800 x 1610

Avec verre acrylique transparent gris 3mm

With 3mm gray transparent acryl glass

Mit 3mm grau transparent Acrylglas

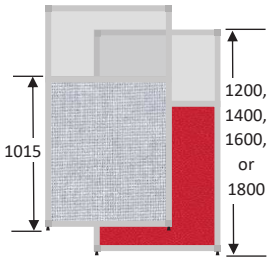

Ref. FTG 1200 x 610
Ref. FTG 1200 x 810
Ref. FTG 1200 x 1010
Ref. FTG 1200 x 1210
Ref. FTG 1200 x 1410
Ref. FTG 1200 x 1610

Ref. FTG 1400 x 610
Ref. FTG 1400 x 810
Ref. FTG 1400 x 1010
Ref. FTG 1400 x 1210
Ref. FTG 1400 x 1410
Ref. FTG 1400 x 1610

Ref. FTG 1600 x 610
Ref. FTG 1600 x 810
Ref. FTG 1600 x 1010
Ref. FTG 1600 x 1210
Ref. FTG 1600 x 1410
Ref. FTG 1600 x 1610

Ref. FTG 1800 x 610
Ref. FTG 1800 x 810
Ref. FTG 1800 x 1010
Ref. FTG 1800 x 1210
Ref. FTG 1800 x 1410
Ref. FTG 1800 x 1610

Avec verre acrylique incolore 3mm

With 3mm colourless acryl glass

Mit 3mm Klaracrylglas

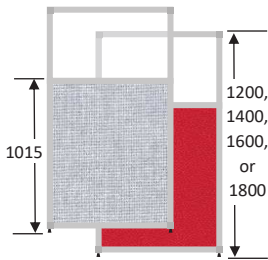

Ref. FTJ 1200 x 610
Ref. FTJ 1200 x 810
Ref. FTJ 1200 x 1010
Ref. FTJ 1200 x 1210
Ref. FTJ 1200 x 1410
Ref. FTJ 1200 x 1610

Ref. FTJ 1400 x 610
Ref. FTJ 1400 x 810
Ref. FTJ 1400 x 1010
Ref. FTJ 1400 x 1210
Ref. FTJ 1400 x 1410
Ref. FTJ 1400 x 1610

Ref. FTJ 1600 x 610
Ref. FTJ 1600 x 810
Ref. FTJ 1600 x 1010
Ref. FTJ 1600 x 1210
Ref. FTJ 1600 x 1410
Ref. FTJ 1600 x 1610

Ref. FTJ 1800 x 610
Ref. FTJ 1800 x 810
Ref. FTJ 1800 x 1010
Ref. FTJ 1800 x 1210
Ref. FTJ 1800 x 1410
Ref. FTJ 1800 x 1610

Avec verre acrylique opale 3mm

With 3mm opal acryl glass

Mit 3mm Opalacrylglas

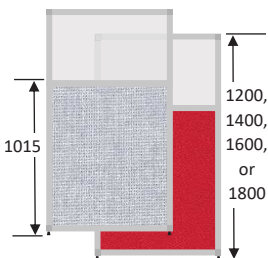

Ref. FTL 1200 x 610
Ref. FTL 1200 x 810
Ref. FTL 1200 x 1010
Ref. FTL 1200 x 1210
Ref. FTL 1200 x 1410
Ref. FTL 1200 x 1610

Ref. FTL 1400 x 610
Ref. FTL 1400 x 810
Ref. FTL 1400 x 1010
Ref. FTL 1400 x 1210
Ref. FTL 1400 x 1410
Ref. FTL 1400 x 1610

Ref. FTL 1600 x 610
Ref. FTL 1600 x 810
Ref. FTL 1600 x 1010
Ref. FTL 1600 x 1210
Ref. FTL 1600 x 1410
Ref. FTL 1600 x 1610

Ref. FTL 1800 x 610
Ref. FTL 1800 x 810
Ref. FTL 1800 x 1010
Ref. FTL 1800 x 1210
Ref. FTL 1800 x 1410
Ref. FTL 1800 x 1610

Avec polycarbonate alvéolaire incolore 6mm

With 6mm clear alveolar polycarbonate

Mit 6mm Klarpolycarbonat

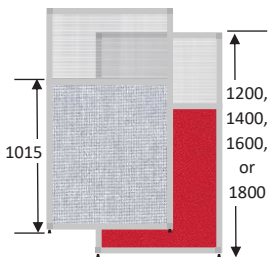

Ref. FTP 1200 x 610
Ref. FTP 1200 x 810
Ref. FTP 1200 x 1010
Ref. FTP 1200 x 1210
Ref. FTP 1200 x 1410
Ref. FTP 1200 x 1610

Ref. FTP 1400 x 610
Ref. FTP 1400 x 810
Ref. FTP 1400 x 1010
Ref. FTP 1400 x 1210
Ref. FTP 1400 x 1410
Ref. FTP 1400 x 1610

Ref. FTP 1600 x 610
Ref. FTP 1600 x 810
Ref. FTP 1600 x 1010
Ref. FTP 1600 x 1210
Ref. FTP 1600 x 1410
Ref. FTP 1600 x 1610

Ref. FTP 1800 x 610
Ref. FTP 1800 x 810
Ref. FTP 1800 x 1010
Ref. FTP 1800 x 1210
Ref. FTP 1800 x 1410
Ref. FTP 1800 x 1610



Chaque cloisonnette est livrée avec un kit de montage (voir page 13)

A fitting set is supplied with each partition (see page 13)

Ein Bausatz versorgt mit jeder Stellwand (siehe Seite 13)



✓ **ABSORPTION PHONIQUE
MODEREE**

2 x 5mm mousse + tissu
&
Verre acrylique /
Polycarbonate alvéolaire

Hauteurs 1400 & 1600mm



✓ **CONTROLLED SOUND
ABSORPTION**

2 x 5mm Foam + Fabric
&
Acryl glass /
Alveolar polycarbonate
screens

1400 & 1600mm High



✓ **MAßVOLLE
SCHALLABSORBTION**

2 x 5 mm Schaum + Stoff
&
Acrylglas /
Polycarbonat Stellwände

Höhe 1400 & 1600mm





GAMME SUPER-ACOUSTIQUE

TESTS ACOUSTIQUES PAGE 46

Les panneaux Super-Acoustiques peuvent être fixés au mur, suspendus au plafond ou, comme toute autre cloisonnette Reyem, utilisés comme écran de bureau ou séparation d'ambiance.

2 x 15mm d'absorbant acoustique en fibre de polyester

- + 2 x 5mm de Medium Density Fibreboard (MDF)
- + Tissu



SUPER-ACOUSTIC RANGE

ACOUSTIC TESTS PAGE 46

Super-Acoustic panels can be wall-mounted, suspended from the ceiling or, like all other Reyem screen systems, be used as a desk screen or office partition.

2 x 15mm polyester fibre acoustic absorbent

- + 2 x 5mm Medium Density Fibreboard (MDF)
- + Fabric



SUPER-AKUSTIK-PRODUKTREIHE

AKUSTIK-TESTE SEITE 46

Die Super-Akustik-Wände können an der Wand befestigt, an der Decke aufgehängt oder – wie alle anderen Reyem-Stellwände – als Tisch-Trennwand oder Raumteiler verwendet werden.

2 x 15mm Schalldämmstoff aus Polyesterfaser

- + 2 x 5mm Medium Density Fibreboard (MDF)
- + Stoff





✓ **UNE ABSORPTION
PHONIQUE OPTIMALE**



✓ **OPTIMAL SOUND
ABSORPTION**



✓ **OPTIMALE
SCHALLABSORPTION**





CLOISONNETTES SUPER-ACOUSTIQUES

TISSU CARA ou LUCIA
Coloris page 45



SUPER-ACOUSTIC SCREENS

CARA FABRIC or LUCIA
Colours page 45



SUPER-AKUSTIK- STELLWÄNDE

CARA STOFF ODER LUCIA
Farben Seite 45

Hauteur
 Height
 Höhe

1200 mm

1400 mm

1600 mm

1800 mm

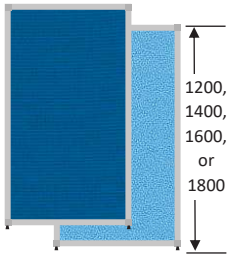

Ref. ATT 1200 x 610
Ref. ATT 1200 x 810
Ref. ATT 1200 x 1010
Ref. ATT 1200 x 1210
Ref. ATT 1200 x 1410
Ref. ATT 1200 x 1610

Ref. ATT 1400 x 610
Ref. ATT 1400 x 810
Ref. ATT 1400 x 1010
Ref. ATT 1400 x 1210
Ref. ATT 1400 x 1410
Ref. ATT 1400 x 1610

Ref. ATT 1600 x 610
Ref. ATT 1600 x 810
Ref. ATT 1600 x 1010
Ref. ATT 1600 x 1210
Ref. ATT 1600 x 1410
Ref. ATT 1600 x 1610

Ref. ATT 1800 x 610
Ref. ATT 1800 x 810
Ref. ATT 1800 x 1010
Ref. ATT 1800 x 1210
Ref. ATT 1800 x 1410
Ref. ATT 1800 x 1610

Avec verre acrylique transparent gris 3mm

With 3mm gray transparent acryl glass

Mit 3mm grau transparent Acrylglas

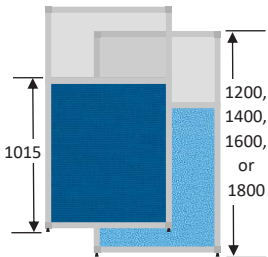

Ref. ATG 1200 x 610
Ref. ATG 1200 x 810
Ref. ATG 1200 x 1010
Ref. ATG 1200 x 1210
Ref. ATG 1200 x 1410
Ref. ATG 1200 x 1610

Ref. ATG 1400 x 610
Ref. ATG 1400 x 810
Ref. ATG 1400 x 1010
Ref. ATG 1400 x 1210
Ref. ATG 1400 x 1410
Ref. ATG 1400 x 1610

Ref. ATG 1600 x 610
Ref. ATG 1600 x 810
Ref. ATG 1600 x 1010
Ref. ATG 1600 x 1210
Ref. ATG 1600 x 1410
Ref. ATG 1600 x 1610

Ref. ATG 1800 x 610
Ref. ATG 1800 x 810
Ref. ATG 1800 x 1010
Ref. ATG 1800 x 1210
Ref. ATG 1800 x 1410
Ref. ATG 1800 x 1610

Avec verre acrylique incolore 3mm

With 3mm colourless acryl glass

Mit 3mm Klaracrylglas

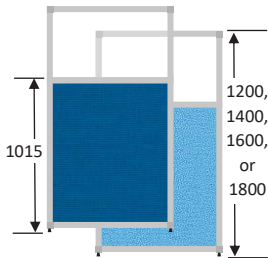

Ref. ATJ 1200 x 610
Ref. ATJ 1200 x 810
Ref. ATJ 1200 x 1010
Ref. ATJ 1200 x 1210
Ref. ATJ 1200 x 1410
Ref. ATJ 1200 x 1610

Ref. ATJ 1400 x 610
Ref. ATJ 1400 x 810
Ref. ATJ 1400 x 1010
Ref. ATJ 1400 x 1210
Ref. ATJ 1400 x 1410
Ref. ATJ 1400 x 1610

Ref. ATJ 1600 x 610
Ref. ATJ 1600 x 810
Ref. ATJ 1600 x 1010
Ref. ATJ 1600 x 1210
Ref. ATJ 1600 x 1410
Ref. ATJ 1600 x 1610

Ref. ATJ 1800 x 610
Ref. ATJ 1800 x 810
Ref. ATJ 1800 x 1010
Ref. ATJ 1800 x 1210
Ref. ATJ 1800 x 1410
Ref. ATJ 1800 x 1610

Avec verre acrylique opale 3mm

With 3mm opal acryl glass

Mit 3mm Opalacrylglas

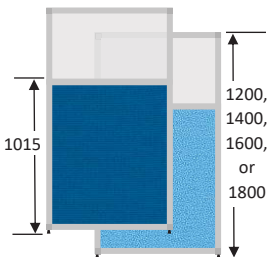

Ref. ATL 1200 x 610
Ref. ATL 1200 x 810
Ref. ATL 1200 x 1010
Ref. ATL 1200 x 1210
Ref. ATL 1200 x 1410
Ref. ATL 1200 x 1610

Ref. ATL 1400 x 610
Ref. ATL 1400 x 810
Ref. ATL 1400 x 1010
Ref. ATL 1400 x 1210
Ref. ATL 1400 x 1410
Ref. ATL 1400 x 1610

Ref. ATL 1600 x 610
Ref. ATL 1600 x 810
Ref. ATL 1600 x 1010
Ref. ATL 1600 x 1210
Ref. ATL 1600 x 1410
Ref. ATL 1600 x 1610

Ref. ATL 1800 x 610
Ref. ATL 1800 x 810
Ref. ATL 1800 x 1010
Ref. ATL 1800 x 1210
Ref. ATL 1800 x 1410
Ref. ATL 1800 x 1610

Avec polycarbonate alvéolaire incolore 6mm

With 6mm clear alveolar polycarbonate

Mit 6mm Klarpolycarbonat

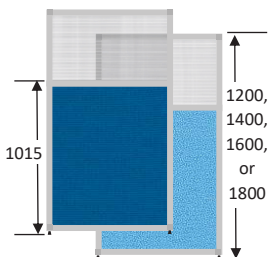

Ref. ATP 1200 x 610
Ref. ATP 1200 x 810
Ref. ATP 1200 x 1010
Ref. ATP 1200 x 1210
Ref. ATP 1200 x 1410
Ref. ATP 1200 x 1610

Ref. ATP 1400 x 610
Ref. ATP 1400 x 810
Ref. ATP 1400 x 1010
Ref. ATP 1400 x 1210
Ref. ATP 1400 x 1410
Ref. ATP 1400 x 1610

Ref. ATP 1600 x 610
Ref. ATP 1600 x 810
Ref. ATP 1600 x 1010
Ref. ATP 1600 x 1210
Ref. ATP 1600 x 1410
Ref. ATP 1600 x 1610

Ref. ATP 1800 x 610
Ref. ATP 1800 x 810
Ref. ATP 1800 x 1010
Ref. ATP 1800 x 1210
Ref. ATP 1800 x 1410
Ref. ATP 1800 x 1610



Chaque cloisonnette est livrée avec un kit de montage (voir page 13)

A fitting set is supplied with each partition (see page 13)

Ein Bausatz versorgt mit jeder Stellwand (siehe Seite 13)

Pour d'autres dimensions, consultez-nous
Coloris des tissus en page 45

For other dimensions, please contact us
For fabric colours, see page 45

Für andere Maße, kontaktieren Sie uns
Für Stofffarben, siehe Seite 45



Fixation pour panneaux suspendus



Fixing for hanging panels



Befestigung für Hängepaneele



1 x APS + APC



2 x APS + APC



Ref. APS

Ref. APC

- Chaîne diamètre 2mm
- Chain diameter 2mm
- Kette Durchmesser 2mm

Fixation pour panneaux muraux

Fixing for wall panels

Befestigung für Wandpaneele

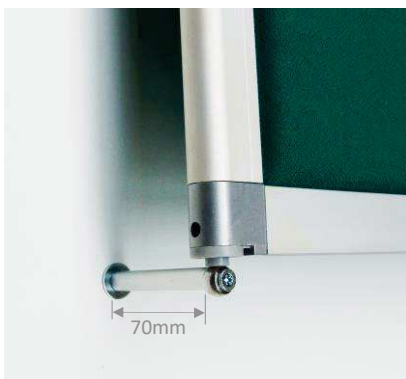

Ref. APM



CLOISONNETTES VERRE ACRYLIQUE & POLYCARBONATE



ACRYL GLASS & POLYCARBONATE SCREENS



ACRYLGLAS & KLARPOLYCARBONAT STELLWÄNDE

Hauteur
 Height
 Höhe

1200 mm

1400 mm

1600 mm

1800 mm

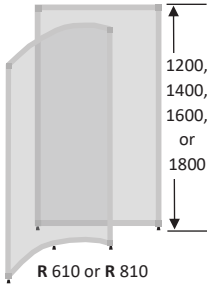

Ref. MAG 1200 x 610
Ref. MAG 1200 x 810
Ref. MAG 1200 x 1010
Ref. MAG 1200 x 1210

Ref. MAG 1200 x R 610
Ref. MAG 1200 x R 810

Verre acrylique transparent gris 3mm
 3mm gray transparent acryl glass
 3mm grau transparent Acrylglas

Ref. MAG 1400 x 610
Ref. MAG 1400 x 810
Ref. MAG 1400 x 1010
Ref. MAG 1400 x 1210

Ref. MAG 1400 x R 610
Ref. MAG 1400 x R 810

Ref. MAG 1600 x 610
Ref. MAG 1600 x 810
Ref. MAG 1600 x 1010
Ref. MAG 1600 x 1210

Ref. MAG 1600 x R 610
Ref. MAG 1600 x R 810

Ref. MAG 1800 x 610
Ref. MAG 1800 x 810
Ref. MAG 1800 x 1010
Ref. MAG 1800 x 1210

Ref. MAG 1800 x R 610
Ref. MAG 1800 x R 810

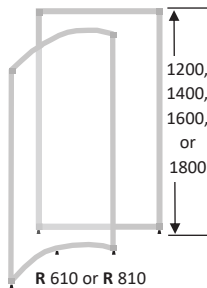

Ref. MAJ 1200 x 610
Ref. MAJ 1200 x 810
Ref. MAJ 1200 x 1010
Ref. MAJ 1200 x 1210

Ref. MAJ 1200 x R 610
Ref. MAJ 1200 x R 810

Verre acrylique incolore 3mm
 3mm colourless acryl glass
 3mm Klaracrylglas

Ref. MAJ 1400 x 610
Ref. MAJ 1400 x 810
Ref. MAJ 1400 x 1010
Ref. MAJ 1400 x 1210

Ref. MAJ 1400 x R 610
Ref. MAJ 1400 x R 810

Ref. MAJ 1600 x 610
Ref. MAJ 1600 x 810
Ref. MAJ 1600 x 1010
Ref. MAJ 1600 x 1210

Ref. MAJ 1600 x R 610
Ref. MAJ 1600 x R 810

Ref. MAJ 1800 x 610
Ref. MAJ 1800 x 810
Ref. MAJ 1800 x 1010
Ref. MAJ 1800 x 1210

Ref. MAJ 1800 x R 610
Ref. MAJ 1800 x R 810

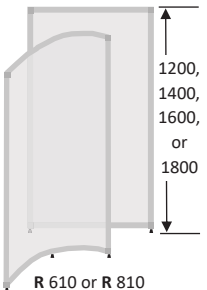

Ref. MAL 1200 x 610
Ref. MAL 1200 x 810
Ref. MAL 1200 x 1010
Ref. MAL 1200 x 1210

Ref. MAL 1200 x R 610
Ref. MAL 1200 x R 810

Verre acrylique opale 3mm
 3mm opal acryl glass
 3mm Opalacrylglas

Ref. MAL 1400 x 610
Ref. MAL 1400 x 810
Ref. MAL 1400 x 1010
Ref. MAL 1400 x 1210

Ref. MAL 1400 x R 610
Ref. MAL 1400 x R 810

Ref. MAL 1600 x 610
Ref. MAL 1600 x 810
Ref. MAL 1600 x 1010
Ref. MAL 1600 x 1210

Ref. MAL 1600 x R 610
Ref. MAL 1600 x R 810

Ref. MAL 1800 x 610
Ref. MAL 1800 x 810
Ref. MAL 1800 x 1010
Ref. MAL 1800 x 1210

Ref. MAL 1800 x R 610
Ref. MAL 1800 x R 810

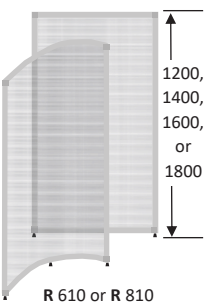

Ref. MAP 1200 x 610
Ref. MAP 1200 x 810
Ref. MAP 1200 x 1010
Ref. MAP 1200 x 1210
Ref. MAP 1200 x 1410
Ref. MAP 1200 x 1610

Ref. MAP 1200 x R 810

Polycarbonate alvéolaire incolore 6mm
 6mm clear alveolar polycarbonate
 6mm Klarpolycarbonat

Ref. MAP 1400 x 610
Ref. MAP 1400 x 810
Ref. MAP 1400 x 1010
Ref. MAP 1400 x 1210
Ref. MAP 1400 x 1410
Ref. MAP 1400 x 1610

Ref. MAP 1400 x R 810

Ref. MAP 1600 x 610
Ref. MAP 1600 x 810
Ref. MAP 1600 x 1010
Ref. MAP 1600 x 1210
Ref. MAP 1600 x 1410
Ref. MAP 1600 x 1610

Ref. MAP 1600 x R 810

Ref. MAP 1800 x 610
Ref. MAP 1800 x 810
Ref. MAP 1800 x 1010
Ref. MAP 1800 x 1210
Ref. MAP 1800 x 1410
Ref. MAP 1800 x 1610

Ref. MAP 1800 x R 810



Chaque cloisonnette est livrée avec un kit de montage (voir page 13)

A fitting set is supplied with each partition (see page 13)

Ein Bausatz versorgt mit jeder Stellwand (siehe Seite 13)



 **Verre acrylique opale**

 **Opal acryl glass**

 **Opalacrylglas**



Transparent gris

Gray transparent

Grau transparent



Incolore

Colourless

Klar



Polycarbonate alvéolaire incolore 6mm
Classement feu M1 / B, s1, d0

6mm colourless alveolar polycarbonate
Fire safety classification B, s1, d0

6mm Klarpolycarbonat
Feuersicherung Class B, s1, d0



Store pour cloisonnettes en
verre acrylique

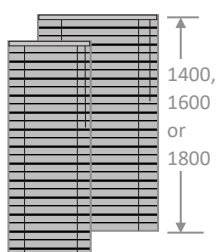

Venetian blind for acryl glass
screens

 **Hauteur**

 **Height** 1400 mm

 **Höhe**

Ref. MVV 1400 x 610
Ref. MVV 1400 x 810
Ref. MVV 1400 x 1010
Ref. MVV 1400 x 1210



Jalousie für Acrylglas Stellwände

1600 mm

1800 mm

Ref. MVV 1600 x 610
Ref. MVV 1600 x 810
Ref. MVV 1600 x 1010
Ref. MVV 1600 x 1210

Ref. MVV 1800 x 610
Ref. MVV 1800 x 810
Ref. MVV 1800 x 1010
Ref. MVV 1800 x 1210



PANNEAUX D’AFFICHAGE
MAGNETIQUES ECRIVABLES



WRITABLE MAGNETIC
NOTICE BOARDS



BESCHREIBBARE MAGNETISCHE
ANSCHLAGTAFELN

Hauteur
 Height
 Höhe

1400 mm

1600 mm

1800 mm

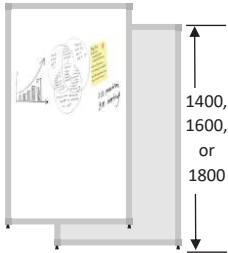

- 1 face magnétique émaillée écrivable + 1 face mélaminé
- 1 enamelled magnetic writable side + 1 side melamine
- 1 emailliert magnetisch und beschreibbar Seite + 1 melaminierte Seite

Ref. TMM 1400 x 610
Ref. TMM 1400 x 810
Ref. TMM 1400 x 1010
Ref. TMM 1400 x 1210

Ref. TMM 1600 x 610
Ref. TMM 1600 x 810
Ref. TMM 1600 x 1010
Ref. TMM 1600 x 1210

Ref. TMM 1800 x 610
Ref. TMM 1800 x 810
Ref. TMM 1800 x 1010
Ref. TMM 1800 x 1210

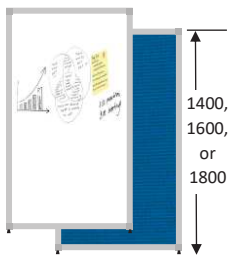

- 1 face magnétique émaillée écrivable + 1 face tissu
- 1 enamelled magnetic writable side + 1 side fabric
- 1 emailliert magnetisch und beschreibbar Seite + 1 Seite Stoff

Ref. TTT 1400 x 610
Ref. TTT 1400 x 810
Ref. TTT 1400 x 1010
Ref. TTT 1400 x 1210

Ref. TTT 1600 x 610
Ref. TTT 1600 x 810
Ref. TTT 1600 x 1010
Ref. TTT 1600 x 1210

Ref. TTT 1800 x 610
Ref. TTT 1800 x 810
Ref. TTT 1800 x 1010
Ref. TTT 1800 x 1210

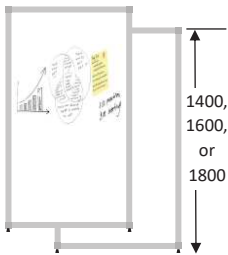

- 2 faces magnétiques émaillées écrivables
- 2 enamelled magnetic writable sides
- 2 emailliert magnetisch und beschreibbar Seiten

Ref. TEX 1400 x 610
Ref. TEX 1400 x 810
Ref. TEX 1400 x 1010
Ref. TEX 1400 x 1210

Ref. TEX 1600 x 610
Ref. TEX 1600 x 810
Ref. TEX 1600 x 1010
Ref. TEX 1600 x 1210

Ref. TEX 1800 x 610
Ref. TEX 1800 x 810
Ref. TEX 1800 x 1010
Ref. TEX 1800 x 1210

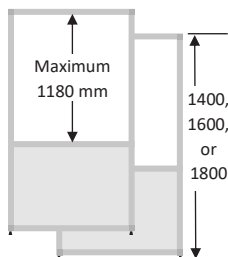

- 2 faces magnétiques émaillées écrivables + Mélaminé
- 2 enamelled magnetic writable sides + Melamine
- 2 emailliert magnetisch und beschreibbar Seiten + Melamin

Ref. TMX 1400 x 610
Ref. TMX 1400 x 810
Ref. TMX 1400 x 1010
Ref. TMX 1400 x 1210
Ref. TMX 1400 x 1410
Ref. TMX 1400 x 1610

Ref. TMX 1600 x 610
Ref. TMX 1600 x 810
Ref. TMX 1600 x 1010
Ref. TMX 1600 x 1210
Ref. TMX 1600 x 1410
Ref. TMX 1600 x 1610

Ref. TMX 1800 x 610
Ref. TMX 1800 x 810
Ref. TMX 1800 x 1010
Ref. TMX 1800 x 1210
Ref. TMX 1800 x 1410
Ref. TMX 1800 x 1610

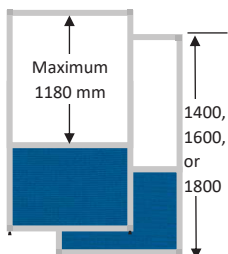

- 2 faces magnétiques émaillées écrivables + Tissu
- 2 enamelled magnetic writable sides + Fabric
- 2 emailliert magnetisch und beschreibbar Seiten + Stoff

Ref. TTX 1400 x 610
Ref. TTX 1400 x 810
Ref. TTX 1400 x 1010
Ref. TTX 1400 x 1210
Ref. TTX 1400 x 1410
Ref. TTX 1400 x 1610

Ref. TTX 1600 x 610
Ref. TTX 1600 x 810
Ref. TTX 1600 x 1010
Ref. TTX 1600 x 1210
Ref. TTX 1600 x 1410
Ref. TTX 1600 x 1610

Ref. TTX 1800 x 610
Ref. TTX 1800 x 810
Ref. TTX 1800 x 1010
Ref. TTX 1800 x 1210
Ref. TTX 1800 x 1410
Ref. TTX 1800 x 1610



- Chaque cloisonnette est livrée avec un kit de montage (voir page 13)
- A fitting set is supplied with each partition (see page 13)
- Ein Bausatz versorgt mit jeder Stellwand (siehe Seite 13)



Tôle perforée magnétique

Magnetic perforated metal sheet

Magnetisch Lochblech

Hauteur
Height
Höhe

1200 mm

1400 mm

1600 mm

1800 mm

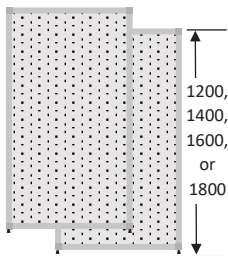

Ref. MPP 1200 x 610
 Ref. MPP 1200 x 810
 Ref. MPP 1200 x 1010

- Tôle perforée magnétique acier laqué RAL 9006
- RAL 9006 lacquered magnetic perforated metal sheet
- Lackierten magnetisch Lochblech RAL 9006

Ref. MPP 1400 x 610
 Ref. MPP 1400 x 810
 Ref. MPP 1400 x 1010

Ref. MPP 1600 x 610
 Ref. MPP 1600 x 810
 Ref. MPP 1600 x 1010

Ref. MPP 1800 x 610
 Ref. MPP 1800 x 810
 Ref. MPP 1800 x 1010

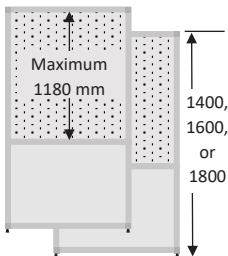

- Tôle perforée magnétique acier laqué RAL 9006 + Mélaminé
- RAL 9006 lacquered magnetic perforated metal sheet + Melamine
- Lackierten magnetisch Lochblech RAL 9006 + Melamin

Ref. MPM 1400 x 610
 Ref. MPM 1400 x 810
 Ref. MPM 1400 x 1010
 Ref. MPM 1400 x 1210
 Ref. MPM 1400 x 1410
 Ref. MPM 1400 x 1610

Ref. MPM 1600 x 610
 Ref. MPM 1600 x 810
 Ref. MPM 1600 x 1010
 Ref. MPM 1600 x 1210
 Ref. MPM 1600 x 1410
 Ref. MPM 1600 x 1610

Ref. MPM 1800 x 610
 Ref. MPM 1800 x 810
 Ref. MPM 1800 x 1010
 Ref. MPM 1800 x 1210
 Ref. MPM 1800 x 1410
 Ref. MPM 1800 x 1610

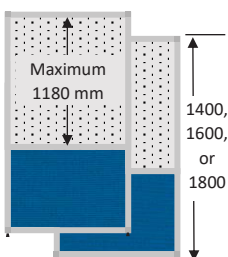

- Tôle perforée magnétique acier laqué RAL 9006 + Tissu
- RAL 9006 lacquered magnetic perforated metal sheet + Fabric
- Lackierten magnetisch Lochblech RAL 9006 + Stoff

Ref. MPT 1400 x 610
 Ref. MPT 1400 x 810
 Ref. MPT 1400 x 1010
 Ref. MPT 1400 x 1210
 Ref. MPT 1400 x 1410
 Ref. MPT 1400 x 1610

Ref. MPT 1600 x 610
 Ref. MPT 1600 x 810
 Ref. MPT 1600 x 1010
 Ref. MPT 1600 x 1210
 Ref. MPT 1600 x 1410
 Ref. MPT 1600 x 1610

Ref. MPT 1800 x 610
 Ref. MPT 1800 x 810
 Ref. MPT 1800 x 1010
 Ref. MPT 1800 x 1210
 Ref. MPT 1800 x 1410
 Ref. MPT 1800 x 1610



ACCESSOIRES
POUR CLOISONNETTES



ACCESSORIES
FOR SCREENS



ZUBEHÖR
FÜR STELLWÄNDE



- Rehausse en verre trempé dépoli 5mm
- 5mm frosted tempered glass (securit)
- Aufsatz aus gehärtetem Mattglas 5mm stark (securit)

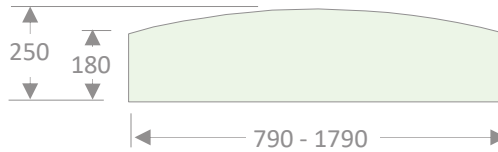

- Ref. MGD 250 x 790
- Ref. MGD 250 x 990
- Ref. MGD 250 x 1190
- Ref. MGD 250 x 1390
- Ref. MGD 250 x 1590
- Ref. MGD 250 x 1790

- Clip pour verre de 4 à 10mm avec écrou
- Clip for 4 to 10mm glass with nut
- Klip für 4 bis 10mm starkes Glas mit Mutter

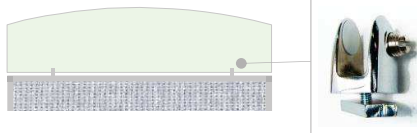

Ref. MVU 002

- Crochet métallique
- Metal hook
- Metalhaken



Ref. MVD 200

- Crochet porte manteau
- Coatrack hook
- Kleiderhaken



Ref. MVC 111

- Profilé d'obturation en PVC souple gris
- Shutterprofile, flexible grey PVC
- Verstopfprofile aus grau Weich-PVC



Ref. MVX 001

- Étagère 320 x 320 x 760mm
- Shelf 320 x 320 x 760mm
- Regale 320 x 320 x 760mm



Ref. MVE 800

Pied de stabilisation

Stabilization foot

Stabilisation Fuß

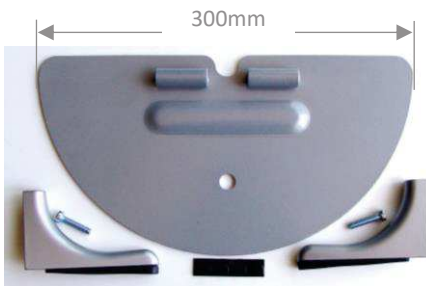

Ref. MVP 300

Pied Réglable

Adjustable foot

Verstellbarer Fuß

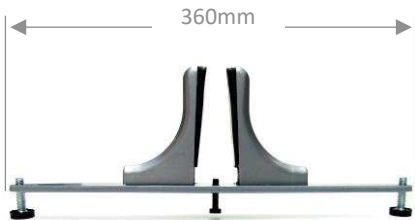

Ref. MVP 360

Nombre de pieds suivant l'implantation :

Number of feet required depends on the layout:

Zahl der Füße kommt darauf das Layout an:

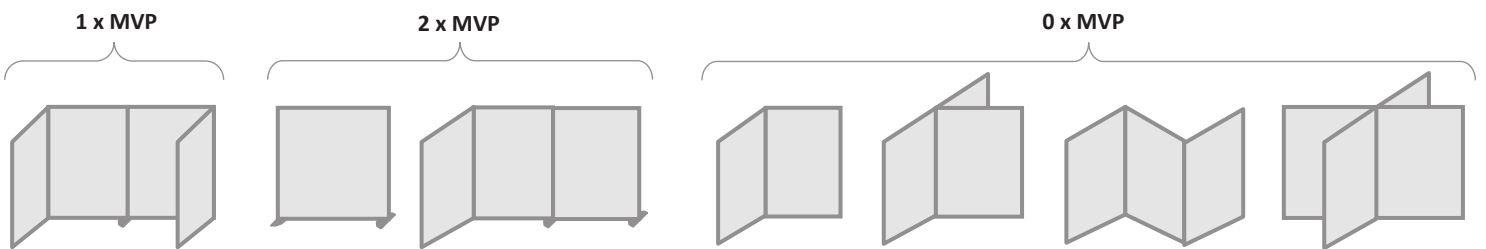

**Kit complet 4 roulettes avec freins
+ 2 barres**
(pour hauteur maxi 1800mm)

4 locking castor full set + 2 bars
(for maximum height 1800mm)

**Komplettsatz mit 4 Rollen mit
Bremsfunktion**
(für maxi Höhe 1800mm)

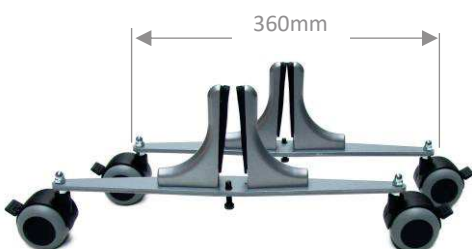

Ref. MVX 380



CLOISONS MOBILES A ANGLE DROIT SUR ROULETTES

Les Cloisons Reyem à angle droit sur 3 roulettes permettent de séparer rapidement vos espaces, peuvent être utilisées dans des salles polyvalentes, musées, expositions...

Mélaminé blanc de 8 mm
Pour d'autres coloris, veuillez nous consulter.
Ensemble de deux cloisons + kit 3 roulettes

Ref. PAS 2100 1410 / 710

Possible en PVC blanc de 8 mm,
Classé feu **M1 / B, s3, d0**
Veuillez nous consulter



FREESTANDING ANGLE PARTITIONS ON CASTORS

The three-castor free-standing partitions by Reyem are a fast and easy solution to separate your spaces. They can be used in function rooms, museums, exhibitions and many other locations...

8mm white melamine
For other colours, please contact us.
Two partitions + 3 castor kit

Ref. PAS 2100 1410 / 710

8mm white PVC possible,
Fire safety classification **B, s3, d0**
Please contact us



BEWEGLICHE ECKTRENNWÄNDE AUF ROLLEN

Die rechtwinkligen Reyem Trennwände auf 3 Rollen ermöglichen Ihnen eine schnelle Raumteilung und können in Mehrzweckhallen, Museen, Ausstellungsräumen usw. eingesetzt werden.

8 mm weiß Melamin,
Für andere Farbe, kontaktieren Sie uns.
Einheit aus zwei Trennwänden + 3 Rollen satz

Ref. PAS 2100 1410 / 710

8 mm Weiß PVC möglich,
Feuersicherung Class **B, s3, d0**
Kontaktieren Sie uns

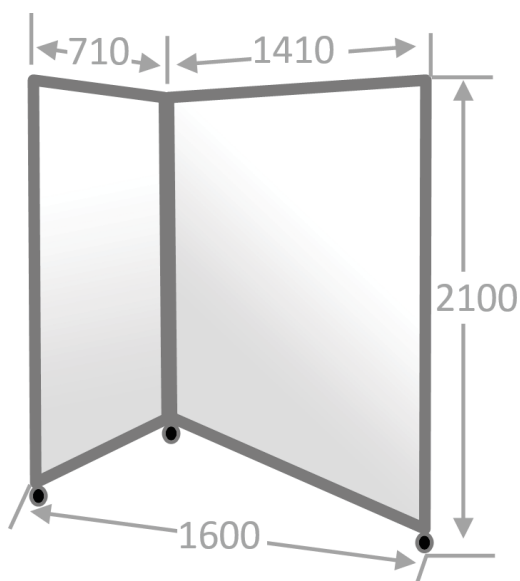

Ref. PAS 2100 1410 / 710



- Kit 3 roulettes uniquement
- 3 castor kit only
- Einzel 3 Rollensatz

Ref. EP 57



- ✓ **BONNE STABILITE**
- ✓ **FACILE A DEPLACER ET A ASSEMBLER**
- ✓ **GAIN DE PLACE LORS DU RANGEMENT**



- ✓ **A STABLE SOLUTION**
- ✓ **EASY TO TRANSPORT AND ASSEMBLE**
- ✓ **SAVE VALUABLE STORAGE SPACE**



- ✓ **GUTE STABILITÄT**
- ✓ **EINFACH BEWEGBAR & ZUSAMMENBAUBAR**
- ✓ **PLATZSPAREND VERSTAUBAR**

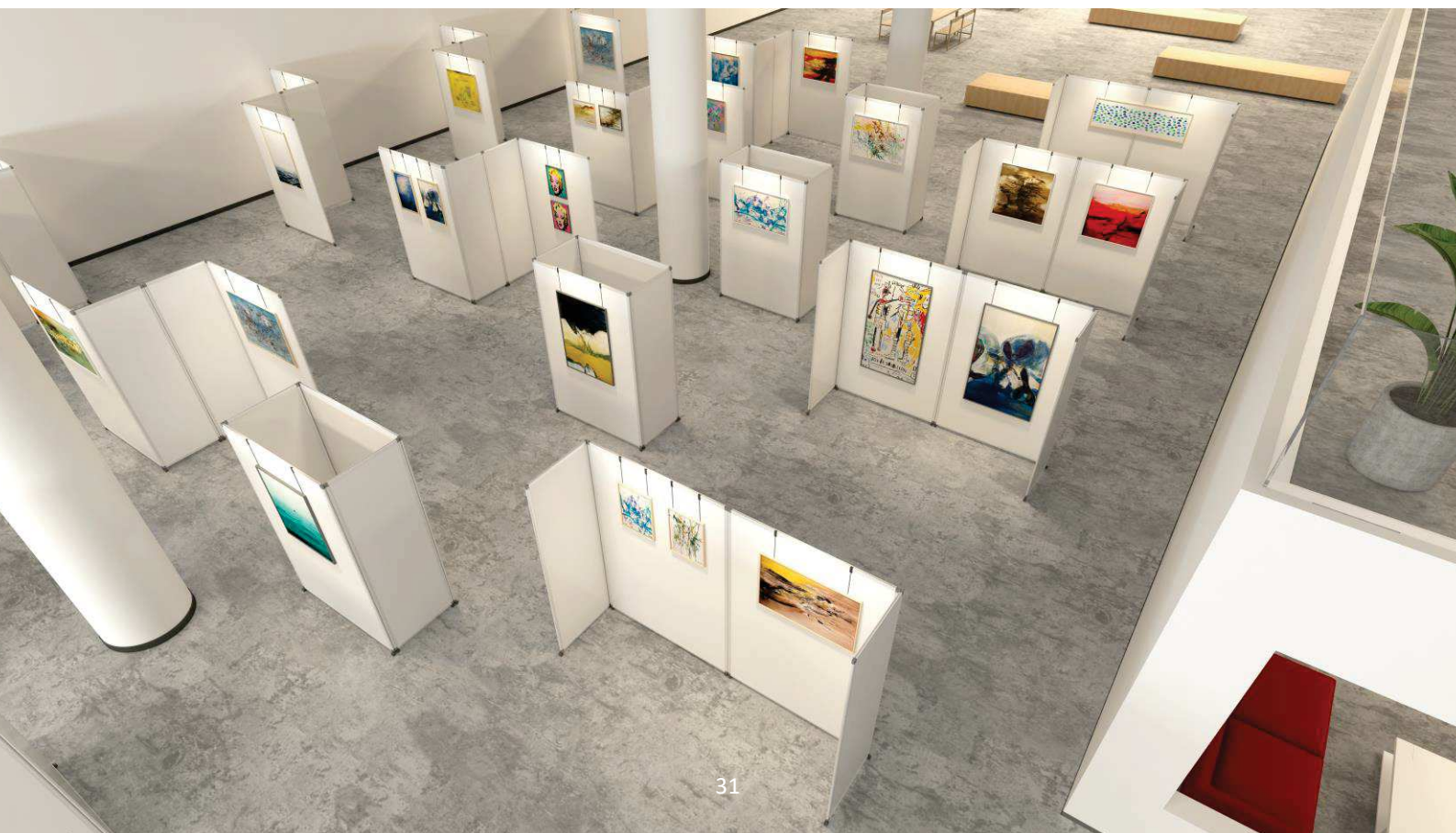



CLOISONS MOBILES
A ANGLE DROIT SUR
ROULETTES



FREESTANDING
ANGLE PARTITIONS
ON CASTORS



BEWEGLISCHE
TRENNWÄNDE AUF
ROLLEN



Les panneaux mobiles à angle droit se rangent facilement dans un coin.
 The angle partitions can easily be stored in a room corner.
 Die bewegliche Trennwände können einfach in einer Ecke eingestellt werden.





PANNEAUX POUR
BANQUE D'ACCUEIL



PANELS FOR
RECEPTION DESK



WÄNDE FÜR
EMPFANGSTHEKE

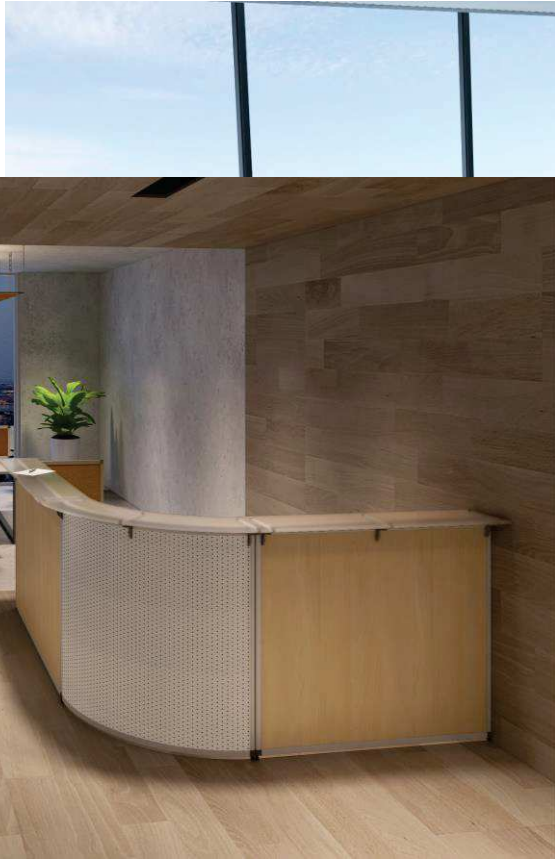

- Mèlaminé 19mm*
- 19mm melamine*
- 19mm Melamin*

Hauteur
Height 1030mm
Höhe

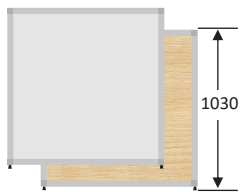

- Ref. MMM 1030 x 800
- Ref. MMM 1030 x 825
- Ref. MMM 1030 x 1000
- Ref. MMM 1030 x 1200
- Ref. MMM 1030 x 1400
- Ref. MMM 1030 x 1600

- Tôle perforée acier laqué RAL 9006
- RAL 9006 lacquered perforated metal sheet
- Lackierten Lochblech RAL 9006

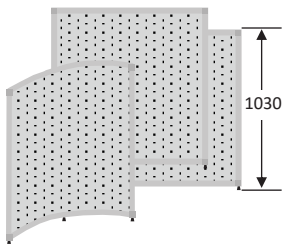

- Ref. MPP 1030 x 800
- Ref. MPP 1030 x 825
- Ref. MPP 1030 x 1000
- Ref. MPP 1030 x 1200
- Ref. MPP 1030 x 1400
- Ref. MPP 1030 x 1600
- Ref. MPP 1030 x R 800

- Tablette en verre Securit dépoli 8mm avec supports MCT 230 inclus
- 8mm frosted Securit glass slab with holders MCT 230 included
- Glasplatte, 8mm Securit Mattglas mit Stützer MCT 230 inbegriffen

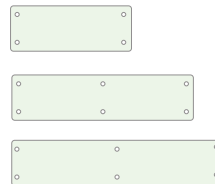

- Ref. MCW 300 x 800
- Ref. MCW 300 x 1000
- Ref. MCW 300 x 1200
- Ref. MCW 300 x 1400
- Ref. MCW 300 x 1600

Ref. MCW 300 x R 800

- Support pour tablette bois ou verre
- Holder for glass or wooden slab
- Stütze für Holz oder Glasplatte

Ref. MCT 230



- Chaque cloisonnette est livrée avec un kit de montage (voir page 13)
- A fitting set is supplied with each partition (see page 13)
- Ein Bausatz versorgt mit jeder Stellwand (siehe Seite 13)

*Version tissu possible, coloris pages 44-45
Pour d'autres dimensions, consultez-nous

*Fabric version possible: colours pages 44-45
For other dimensions, please contact us

*Stoff möglich, für Farben, siehe Seiten 44-45
Für andere Maße, kontaktieren Sie uns



POSTES DE TRAVAIL



WORKSTATIONS



ARBEITSPLÄTZE

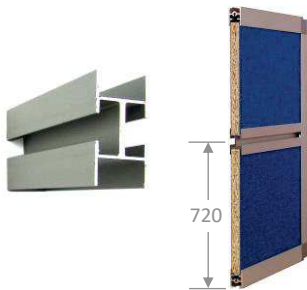
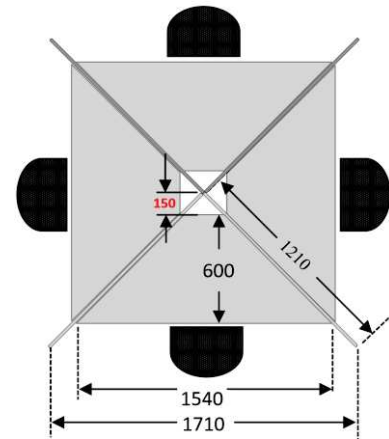
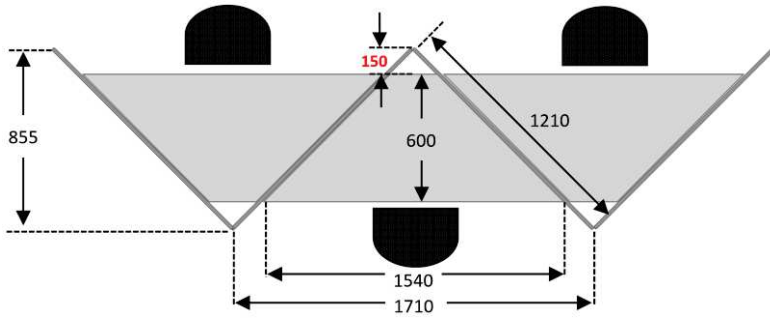

FR Rail aluminium pour fixation plateau ou accessoires (voir page 43).
A intégrer dans la cloison.

UK Aluminum profile for desk surfaces or accessories (see page 43).
To be integrated into the screen.

DE Alu-Profil für Tischplatten-Befestigung oder Zubehör (siehe Seite 43). In die Wand einzulassen.

Ref. MVH 100/ 610
Ref. MVH 100/ 810
Ref. MVH 100/ 1010
Ref. MVH 100/ 1210
Ref. MVH 100/ 1410
Ref. MVH 100/ 1610
Ref. MVH 100/ 1810



FR 4 Supports pour plateau
UK 4 Holders for desk surfaces
DE 4 Halter für Tischplatte

Ref. MVH 110



FR Plateau mélaminé blanc ou gris 28mm + 4 supports MVH 110
UK 28mm thick white or grey desk surface + 4 holders MVH 110
DE 28mm Melamin Tischplatte weiss oder grau + 4 Halterungen MVH 110

Ref. MVH 600 x TRAP



FR Prise compact type E avec chargeur USB 5V / 2,4A
UK E type compact desk power plug with 5V / 2,4A USB charger
DE Kompakte Typ E Schreibtischsteckdose mit USB-Ladefunktion 5V / 2,4A

Ref. MVH 213



FR Goulotte pour câbles longueur 420mm à fixer sous le plateau
UK Cable support 420mm long to fix under the desk surface
DE Kabelwanne 420mm lang unter Tischplatte zu befestigen

Ref. MVH 212

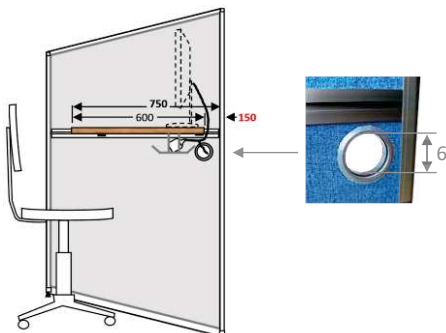
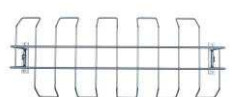

FR Passage pour câbles (à prévoir à la commande)
UK Cable pathway (to be specified when ordered)
DE Kabeldurchführung (Bei Bestellung angeben)

Ref. MVF 111



✓ **OPTIMISATION D'ESPACE**

POSTES DE TRAVAIL

Hauteur 1200mm



✓ **SPACE OPTIMIZATION**

WORKSTATIONS

1200mm High



✓ **RAUMOPTIMIERUNG**

ARBEITSPLÄTZE

Höhe 1200mm

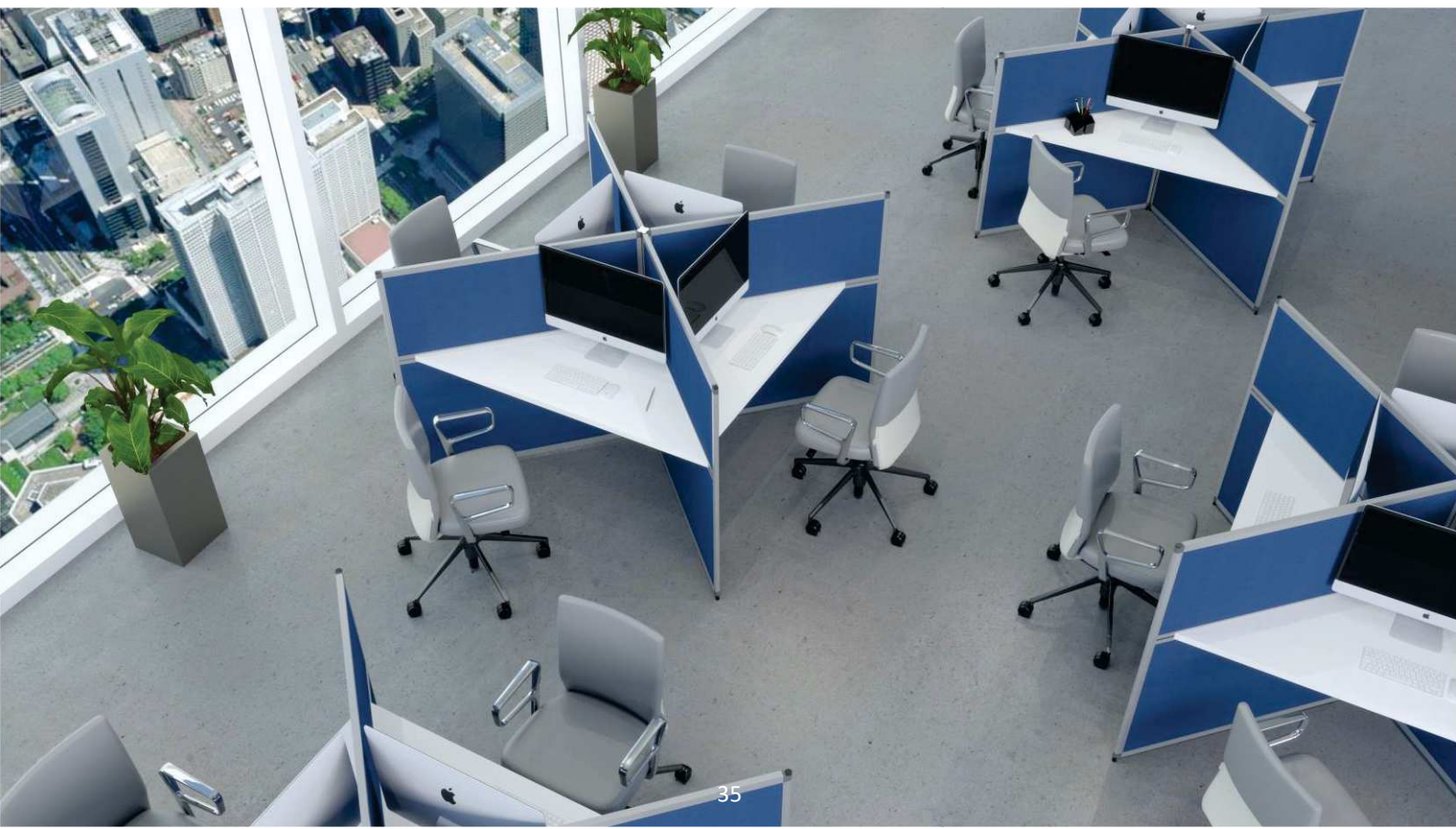



POSTES DE TRAVAIL & CALL CENTER



WORKSTATIONS & CALL CENTER



ARBEITSPLÄTZE & CALL CENTER

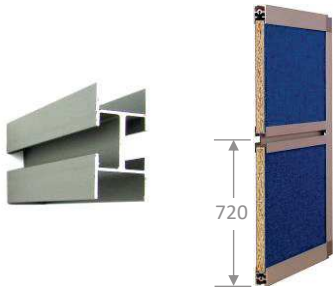
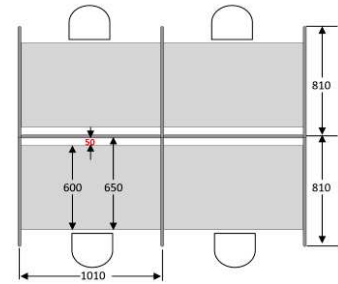
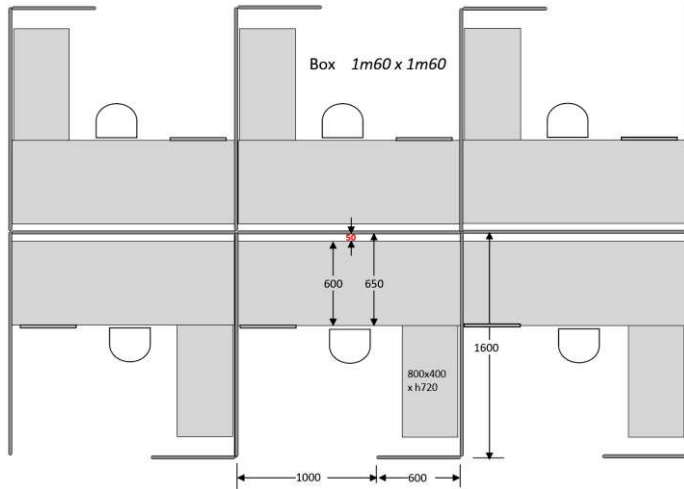

France: Rail aluminium pour fixation plateau ou accessoires (voir page 43).
A intégrer dans la cloison.

UK: Aluminum profile for desk surfaces or accessories (see page 43).
To be integrated into the screen.

Germany: Alu-Profil für Tischplatten-Befestigung oder Zubehör (siehe Seite 43). In die Wand einzulassen.

Ref. MVH 100/ 610
Ref. MVH 100/ 810
Ref. MVH 100/ 1010
Ref. MVH 100/ 1210
Ref. MVH 100/ 1410
Ref. MVH 100/ 1610
Ref. MVH 100/ 1810



France: 4 Supports pour plateau

UK: 4 Holders for desk surfaces

Germany: 4 Halter für Tischplatte

Ref. MVH 110

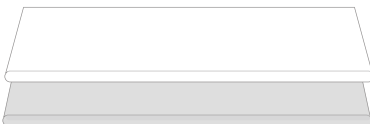

France: Plateau mélaminé blanc ou gris 28mm + 4 supports MVH 110

UK: 28mm thick white or grey desk surface + 4 holders MVH 110

Germany: 28mm Melamin Tischplatte weiss oder grau + 4 Halterungen MVH 110

Ref. MVH 600 x 800
Ref. MVH 600 x 1000
Ref. MVH 600 x 1200
Ref. MVH 600 x 1400
Ref. MVH 600 x 1600



France: Prise compact type E avec chargeur USB 5V / 2,4A

UK: E type compact desk power plug with 5V / 2,4A USB charger

Germany: Kompakte Typ E Schreibtischsteckdose mit USB-Ladefunktion 5V / 2,4A

Ref. MVH 213



France: Goulotte pour câbles longueur 420mm à fixer sous le plateau

UK: Cable support 420mm long to fix under the desk surface

Germany: Kabelwanne 420mm lang under Tischplatte zu befestigen

Ref. MVH 212

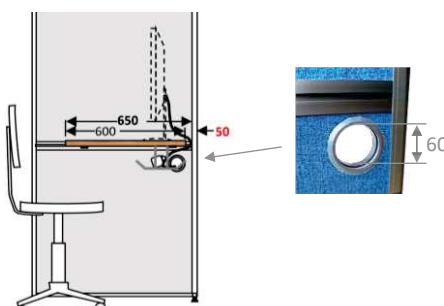
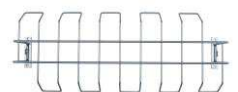

France: Passage pour câbles (à prévoir à la commande)

UK: Cable pathway (to be specified when ordered)

Germany: Kabelndurchführung (Bei Bestellung angeben)

Ref. MVF 111



POSTES DE TRAVAIL

CALL CENTER

Hauteur 1600mm



WORKSTATIONS

CALL CENTER

1600mm High



ARBEITSPLÄTZE

CALL CENTER

Höhe 1600mm





Hauteur
Height
Höhe

350mm

550mm

- Mélaminé 19mm
- 19mm melamine
- 19mm Melamin



Ref. MMB 350 x 800
Ref. MMB 350 x 1000
Ref. MMB 350 x 1200
Ref. MMB 350 x 1400
Ref. MMB 350 x 1600
Ref. MMB 350 x 1800

Ref. MMB 550 x 800
Ref. MMB 550 x 1000
Ref. MMB 550 x 1200
Ref. MMB 550 x 1400
Ref. MMB 550 x 1600
Ref. MMB 550 x 1800

- Tissu Cara ou (**Lucia prix +10%**)
- Cara fabric or (**Lucia fabric price +10%**)
- Cara Stoff oder (**Lucia Stoff Preis +10%**)

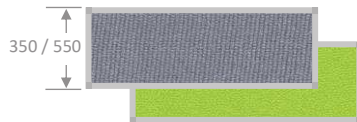

Ref. MTB 350 x 800
Ref. MTB 350 x 1000
Ref. MTB 350 x 1200
Ref. MTB 350 x 1400
Ref. MTB 350 x 1600
Ref. MTB 350 x 1800

Ref. MTB 550 x 800
Ref. MTB 550 x 1000
Ref. MTB 550 x 1200
Ref. MTB 550 x 1400
Ref. MTB 550 x 1600
Ref. MTB 550 x 1800

- Acoustique
- Mousse + Tissu Cara ou (**Lucia prix +10%**)
- Acoustic
- Foam + Cara fabric or (**Lucia fabric price +10%**)
- Akustik
- Schaum + Cara Stoff oder (**Lucia Stoff Preis +10%**)



Ref. FPB 350 x 800
Ref. FPB 350 x 1000
Ref. FPB 350 x 1200
Ref. FPB 350 x 1400
Ref. FPB 350 x 1600
Ref. FPB 350 x 1800

Ref. FPB 550 x 800
Ref. FPB 550 x 1000
Ref. FPB 550 x 1200
Ref. FPB 550 x 1400
Ref. FPB 550 x 1600
Ref. FPB 550 x 1800

- Super-Acoustique
- Tissu Cara ou (**Lucia prix +10%**)
- Super-Acoustic
- Cara fabric or (**Lucia fabric price +10%**)
- Super-Akustik
- Cara Stoff oder (**Lucia Stoff Preis +10%**)

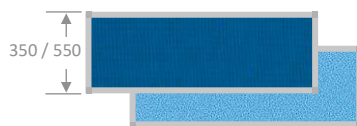

Ref. ATB 350 x 800
Ref. ATB 350 x 1000
Ref. ATB 350 x 1200
Ref. ATB 350 x 1400
Ref. ATB 350 x 1600
Ref. ATB 350 x 1800

Ref. ATB 550 x 800
Ref. ATB 550 x 1000
Ref. ATB 550 x 1200
Ref. ATB 550 x 1400
Ref. ATB 550 x 1600
Ref. ATB 550 x 1800

- Verre Acrylique 3mm
- Transparent gris, incolore ou opale
- 3mm Acryl glass
- Gray transparent, colourless or opal
- 3mm Acrylglas
- Grau transparent, Klar oder Opal



Ref. MVA 350 x 800
Ref. MVA 350 x 1000
Ref. MVA 350 x 1200
Ref. MVA 350 x 1400
Ref. MVA 350 x 1600
Ref. MVA 350 x 1800

Ref. MVA 550 x 800
Ref. MVA 550 x 1000
Ref. MVA 550 x 1200
Ref. MVA 550 x 1400
Ref. MVA 550 x 1600
Ref. MVA 550 x 1800

- Polycarbonate alvéolaire 6mm
- incolore
- 6mm alveolar polycarbonate
- colourless
- 6mm Klarpolycarbonat



Ref. MPB 350 x 800
Ref. MPB 350 x 1000
Ref. MPB 350 x 1200
Ref. MPB 350 x 1400
Ref. MPB 350 x 1600
Ref. MPB 350 x 1800

Ref. MPB 550 x 800
Ref. MPB 550 x 1000
Ref. MPB 550 x 1200
Ref. MPB 550 x 1400
Ref. MPB 550 x 1600
Ref. MPB 550 x 1800

- Magnétique
- Tôle émaillée blanche, écrivable
- Magnetic
- Enameled writable surface
- Magnetisch
- Weiss und trocken abwischbar



Ref. TPB 350 x 800
Ref. TPB 350 x 1000
Ref. TPB 350 x 1200
Ref. TPB 350 x 1400
Ref. TPB 350 x 1600
Ref. TPB 350 x 1800

Ref. TPB 550 x 800
Ref. TPB 550 x 1000
Ref. TPB 550 x 1200
Ref. TPB 550 x 1400
Ref. TPB 550 x 1600
Ref. TPB 550 x 1800



Chaque écran de bureau est livré avec un kit de montage

A fitting set is supplied with each desk screen

Ein Bausatz versorgt mit jeder Trennwand



PANNEAUX ACOUSTIQUES
SUSPENDUS



HANGING ACOUSTIC PANELS



AKUSTIK-HÄNGEPANEELE

ECRANS DE BUREAU
Hauteur 350mm

DESK SCREENS
350mm High

TISCH-TRENNWÄNDE
Höhe 350mm





FIXATION
POUR ECRANS DE BUREAU

Fixation à l'extrémité de l'écran

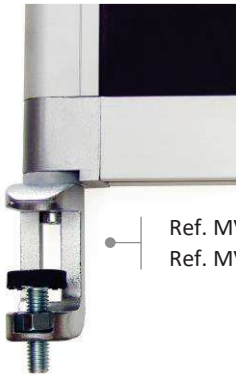

Ref. MVT 280 → 10 – 28mm
Ref. MVT 380 → 20 – 38mm

Prix unitaire
 Unit price
 Stückpreis



FIXING
FOR DESK SCREENS

Fixing on the end of the screen



BEFESTIGUNGEN
FÜR TISCH-TRENNWÄNDE

Befestigung am Ende der Wand



Exemples : Position et quantité de pinces nécessaires selon l'implantation

Example: Clamps position and number required depending on the layout

Beispiele: Klammern Positionen und Mengen erforderlich je nach Standort.

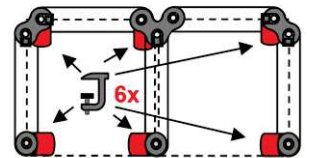
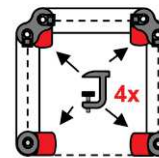
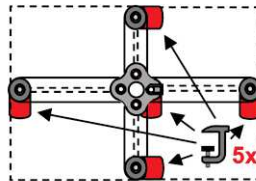
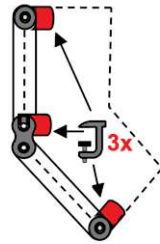
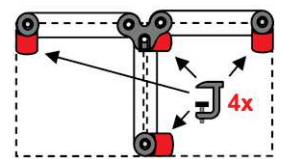
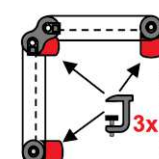
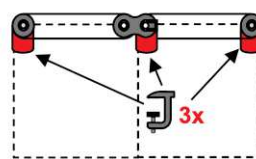
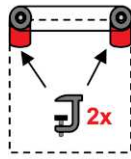

Fixation sur le profilé
Pour bureaux Bench ou
bureaux avec caisson

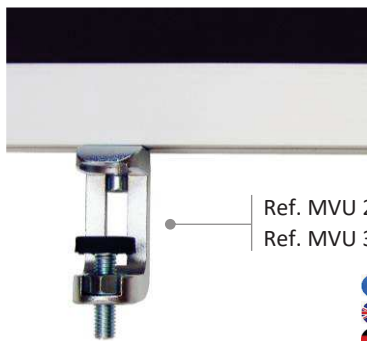

Ref. MVU 280 → 10 – 28mm
Ref. MVU 380 → 20 – 38mm

Prix unitaire
 Unit price
 Stückpreis

Fixing on the profile
For Bench desks or
desks with drawer unit

Befestigung an das Profil
Für Bench Schreibtische oder
Schreibtisch-Unterschrank



Sabot à poser sur le bureau



Base to place on the desk



Sockel auf den Tisch zu legen

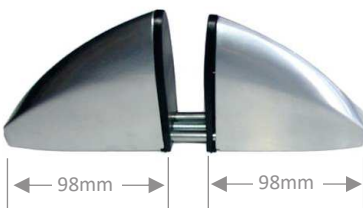

5 - 25mm

Ref. MVZ 200

Prix unitaire
 Unit price
 Stückpreis

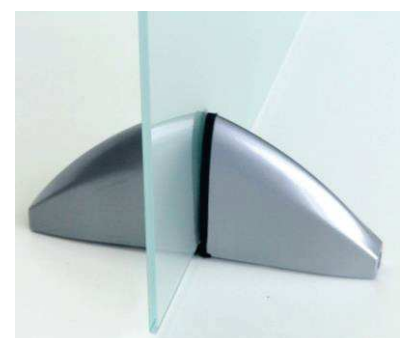



FIXATION
POUR BUREAUX BENCH



FIXING
FOR BENCH DESKS



BEFESTIGUNG
FÜR BENCH SCHREIBTISCHE

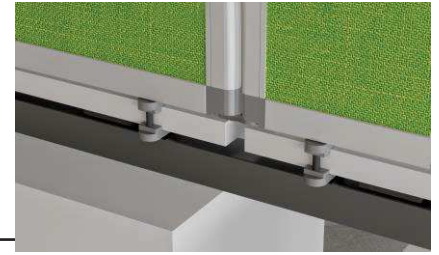

Ref. PBS

Prix unitaire
 Unit price
 Stückpreis



Ref. PBD

Prix unitaire
 Unit price
 Stückpreis

Pinces PBS et PBD disponibles à partir d'août 2020
 PBS and PBD clamps available from August 2020
 PBS und PBD-Klammern ab August 2020 verfügbar



Ref. CYL



Rehausse en verre trempé
dépoli 5mm



5mm frosted tempered glass



Aufsatz aus gehärtetem
Mattglas 5mm stark

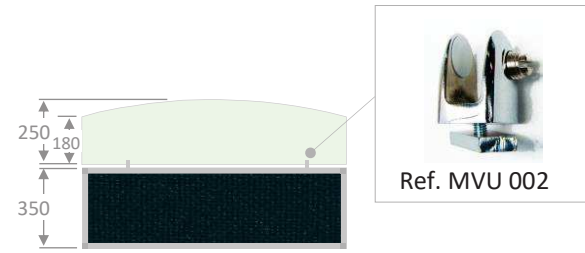

- Clip pour verre de 4 à 10mm avec écrou
- Clip for 4 to 10mm glass with nut
- Klip für 4 bis 10mm starkes Glas mit Mutter

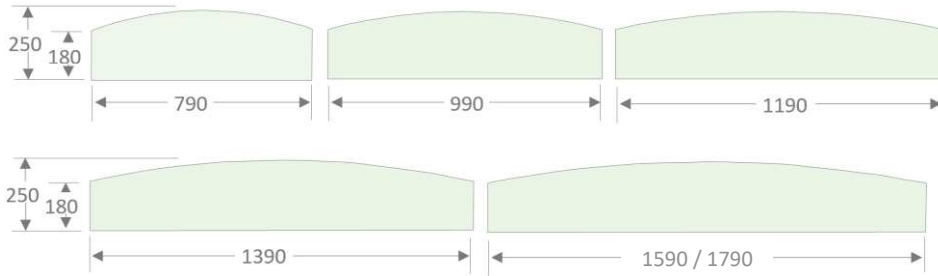

- Ref. MGD 250 x 790
- Ref. MGD 250 x 990
- Ref. MGD 250 x 1190
- Ref. MGD 250 x 1390
- Ref. MGD 250 x 1590
- Ref. MGD 250 x 1790

- Ecrans en verre trempé dépoli 5mm
- Glass desk screens, 5mm frosted tempered glass
- Glaswände aus gehärtetem Mattglas 5mm stark

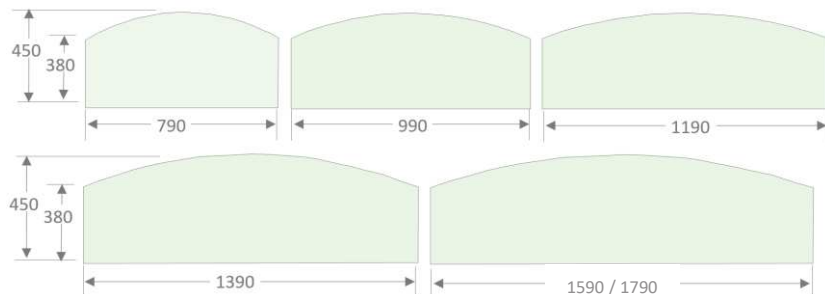

- Ref. MGD 450 x 790
- Ref. MGD 450 x 990
- Ref. MGD 450 x 1190
- Ref. MGD 450 x 1390
- Ref. MGD 450 x 1590
- Ref. MGD 450 x 1790

- Pince bureau métallique + clip pour verre de 4 à 10mm
- Metal desk clamp + clip for 4 to 10mm glass
- Tischklammer + Klip für Glas von 4 bis 10mm

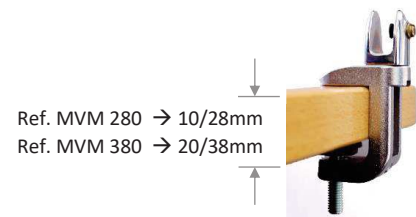



ACCESSOIRES POUR ECRANS DE BUREAU



ACCESSORIES FOR DESK SCREENS



ZUBEHÖR FÜR TISCH-TRENNWÄNDE

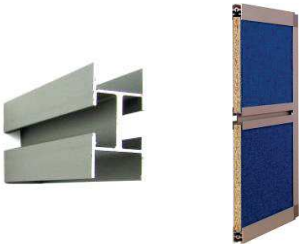

- Rail aluminium pour accessoires sur les 2 faces de la cloison
A prévoir à la fabrication.
- Aluminum profile for accessories on both sides of the screen
Must be specified prior to manufacture.
- Aluschieneprofil für Zubehör an beiden Seiten der Trennwand.
Bei der Herstellung einzuplanen.

Ref. MVH 100/ 610
Ref. MVH 100/ 810
Ref. MVH 100/ 1010
Ref. MVH 100/ 1210
Ref. MVH 100/ 1410
Ref. MVH 100/ 1610
Ref. MVH 100/ 1810



- Plaque pour fixation accessoires 350 x H 330mm
A enclencher sur le profilé haut de la cloison.
- Accessory plate 350 x H 330mm
Interlocks on to the aluminum profile of the screen.
- Platte zur Befestigung von Zubehör 350 x H 330mm
Zum Einrasten am oberen Profil der Trennwand.

Ref. MVH 200



- Bac à Courrier 335 x 250 x 50mm
- Paper tray 335 x 250 x 50mm
- Ablagefach 335 x 250 x 50mm

Ref. MVH 201



- Pot à crayon
- Pen holder
- Stift-Cup

Ref. MVH 204



- Support tablette ou téléphone 80 x 60mm
- Tablet or cell phone holder 80 x 60mm
- Tablet- oder Mobiltelefon-Halterung 80 x 60mm

Ref. MVH 206



- Support inclinable et orientable pour écran LCD de 10 à 23"
Peut être fixé directement sur la cloison avec vis traversantes
ou sur la plaque Ref. MVH 200.

Ref. MVH 209

- 10-23" LCD monitor mount, full rotation
Can be fixed directly on the screen with screws through the
panel or on the plate Ref. MVH 200.

- Neig- und schwenkbare Halterung für 10-23" LCD-Monitor
Kann direkt an der Wand mit durchgehenden Schrauben oder
an der Platte Ref.MVH 200 befestigt werden.





COLORIS MELAMINES



MELAMINE COLORS



MELAMINFARBEN

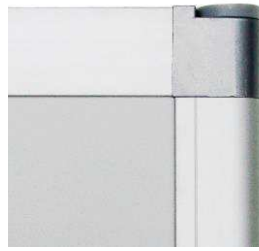

Mélangé d'épaisseur 19mm, fibre du bois horizontal (Epaisseur 8mm possible, voir page 24). 100% PEFC et FSC.

19mm thick melamine, wood fiber horizontal (8mm thick melamine possible, see page 24). 100% PEFC and FSC.

19mm Melamin, Waagrecht Holzfaser (8mm Melamin möglich, siehe Seite 24). 100% PEFC- und FSC-zertifiziert.

SWISS KRONO (www.swisskrono.ch)



375M

Erable
 Maple
 Ahorn



391M

Hêtre
Beech
Buche



854M

Wenge
Wenge
Wenge

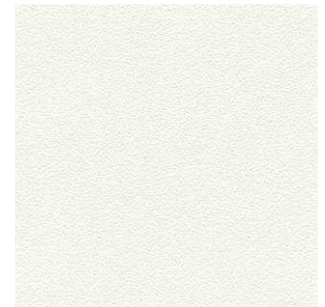

110M

Blanc
White
Weiß



4815VL

Bleu
 Blue
 Blau



2643PE

Vert
Green
Grün



131VL

Jaune
Yellow
Gelb

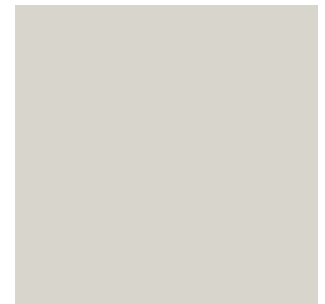

112M

Gris
Grey
Grau

Pour un classement au feu **M1 / B, s2, d0**, d'autres mélaminés ou coloris, veuillez nous consulter.

Les photographies des mélaminés sont présentées à titre indicatif. Des variations de couleurs peuvent se produire. Nous vous conseillons de demander de vrais échantillons.

For **B, s2, d0** fire safety classification, other melamine or colour finishes, please contact us.

The photographs of the melamine finishes are shown as a guideline only. Colours may vary. We recommend that you ask for samples before ordering.

Bei Fragen bezüglich der Brandschutzklasseneinstufung **B, s2, d0**, anderen Melaminbeschichtungen oder Farbtönen wenden Sie sich an uns.

Die Abbildungen der Melaminbeschichtungen sind unverbindlich. Es können Farbabweichungen auftreten. Wir empfehlen Ihnen, echte Probemuster anzufordern.



COLORIS DES TISSUS



FABRIC COLORS



STOFFFARBEN



CAMIRA CARA

www.camirafabrics.com/fabrics-and-samples/cara



Tissu CAMIRA CARA, 100% polypropylène. Flammabilité : BS EN 1021-1:2006 (cigarette).

CAMIRA CARA fabric, 100% polypropylene. Flammability : BS EN 1021-1:2006 (cigarette).

CAMIRA CARA Stoff, 100% Polypropylen. Feuersicherung: BS EN 1021-1:2006 (Zigarette).



105T



125T



154T



186T



015T



076T



038T



192T



173T

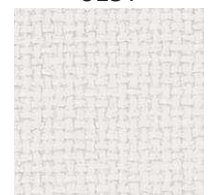

184T

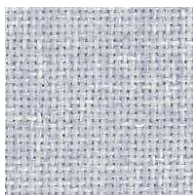

004T

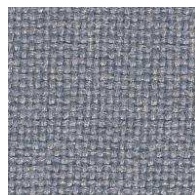

172T



048T

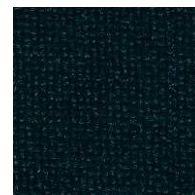

138T

CAMIRA LUCIA

www.camirafabrics.com/fabrics-and-samples/lucia



Tissu CAMIRA LUCIA, 100% polyester recyclé. Flammabilité : BS EN 1021-1&2:2006 (cigarette & allumette). Certifié EU Ecolabel.

CAMIRA LUCIA fabric, 100% recycled polyester. Flammability : BS EN 1021-1&2:2006 (cigarette & matches). Certified EU Ecolabel.

CAMIRA LUCIA Stoff, 100% Polyester recycelt. Feuersicherung: BS EN 1021-1&2:2006 (Zigarette & Spiel). EU Ecolabel-zertifiziert.

Supplément de prix

Additional charge

Preiszuschlag



156L

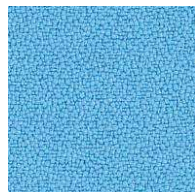

157L

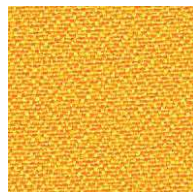

088L

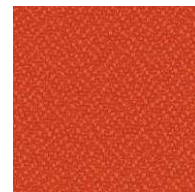

168L

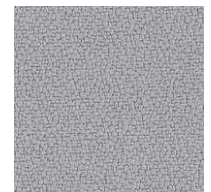

094L



089L



011L



090L



105L



107L

Pour d'autres gammes ou coloris, veuillez nous consulter.

Les photographies des tissus sont présentées à titre indicatif. Des variations de couleurs peuvent se produire. Nous vous conseillons de demander de vrais échantillons.

For other fabric range or colours, please contact us.

The photographs of the fabric finishes are shown as a guideline only. Colours may vary. We recommend that you ask for samples before ordering.

Andere Stoffe oder Farbe, kontaktieren Sie uns.

Die Abbildungen der Stoffbeschichtungen sind unverbindlich. Es können Farbabweichungen auftreten. Wir empfehlen Ihnen, echte Probenmuster anzufordern.



TESTS ACOUSTIQUES



ACOUSTIC TESTS



AKUSTIKTESTE



Méla miné
Melamine
Melamin

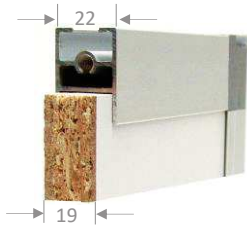

Tissu
Fabric
Stoff

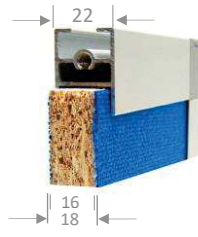

01/04/2009

Acoustique
Acoustic
Akustik

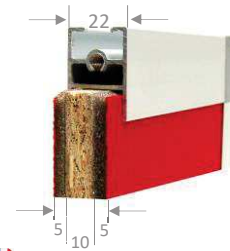

- 2 x 5mm de mousse + tissu
- 2 x 5mm foam + fabric
- 2 x 5mm Schaum + Stoff

Super-acoustique (p. 20)
Super-Acoustic (p. 20)
Super-Akustik (S. 20)

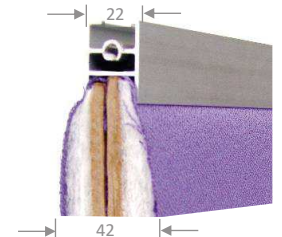

NF EN ISO-354:2004

17/02/2016

α_w	0,05(I)	0,1(I)	0,15(H)	0,45(H)
Frequency (Hz)	α_s			
100	0,00	0,00	0,00	0,13
125	0,00	0,01	0,00	0,19
160	0,02	0,00	0,04	0,22
200	0,00	0,00	0,04	0,26
250	0,03	0,05	0,07	0,30
315	0,02	0,04	0,05	0,28
400	0,02	0,03	0,04	0,32
500	0,01	0,02	0,05	0,36
630	0,03	0,04	0,08	0,41
800	0,02	0,04	0,12	0,45
1000	0,03	0,05	0,14	0,52
1250	0,04	0,08	0,16	0,60
1600	0,03	0,09	0,21	0,70
2000	0,04	0,08	0,24	0,79
2500	0,05	0,10	0,31	0,87
3150	0,04	0,09	0,38	0,91
4000	0,08	0,11	0,44	0,94
5000	0,20	0,21	0,53	0,96

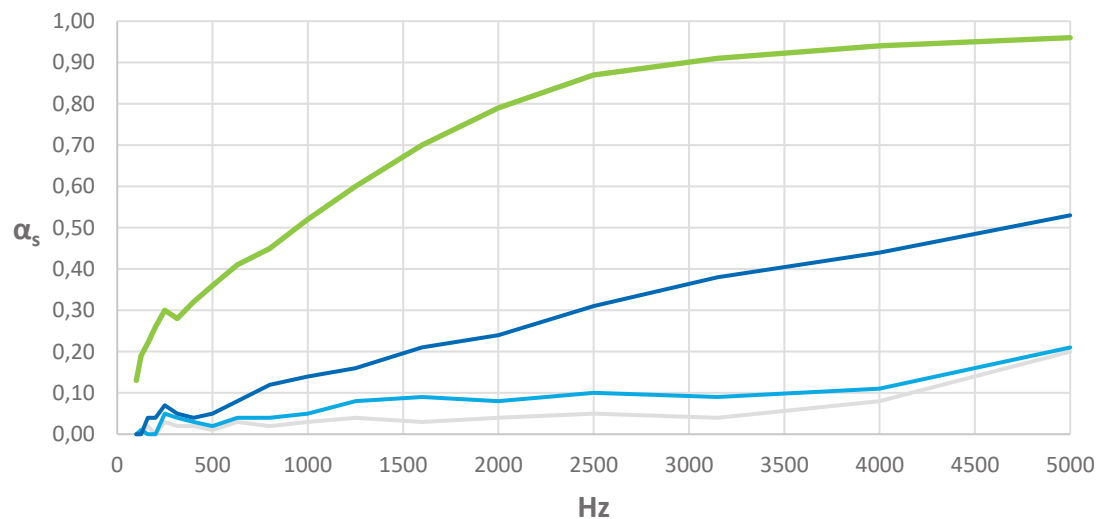
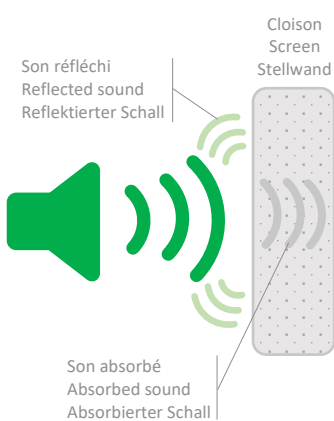

Le coefficient α_s exprime l'absorption de l'énergie sonore par la cloison de 0 à 1 (0 à 100%). Dans les bureaux, les fréquences se situent généralement entre 500 et 4000 Hertz (sons graves ou aigus). Le coefficient α_w exprime l'absorption acoustique pondérée.

The α_s coefficient is used to describe the partition's sound absorption on a scale from 0 to 1 (0 to 100%). In offices, these levels generally remain between 500 and 4000 Hertz (low- or high-pitched sounds). The α_w coefficient describes the weighted acoustic absorption.

Der Koeffizient α_s gibt die von der Trennwand absorbierte Schallenergie von 0 bis 1 (0 bis 100%) an. In Büros liegen die Frequenzen in der Regel zwischen 500 und 4000 Hertz (tiefe oder hohe Töne). Der Koeffizient α_w gibt den gewichteten Schallabsorptionsgrad an.